

TYPICAL INDICATOR ORDERING EXAMPLE

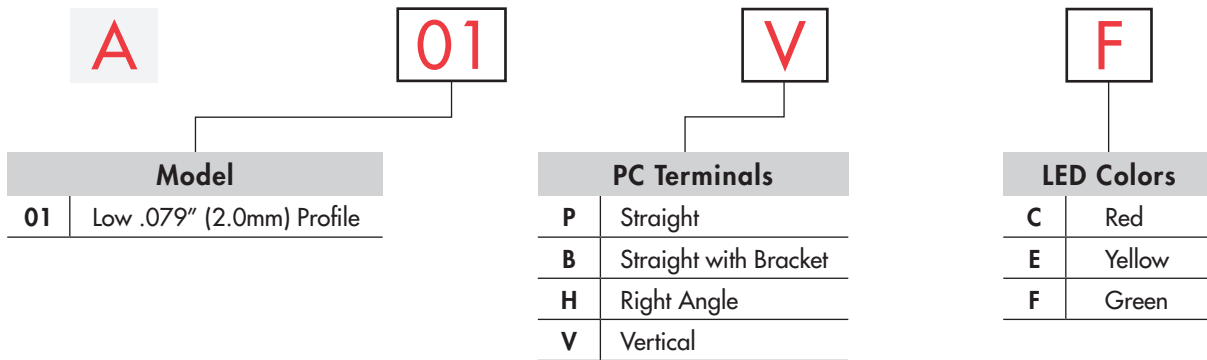

DESCRIPTION FOR TYPICAL ORDERING EXAMPLE

A01VF

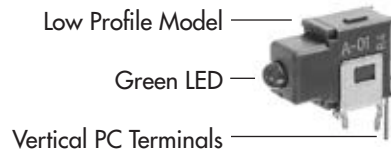

PC TERMINALS

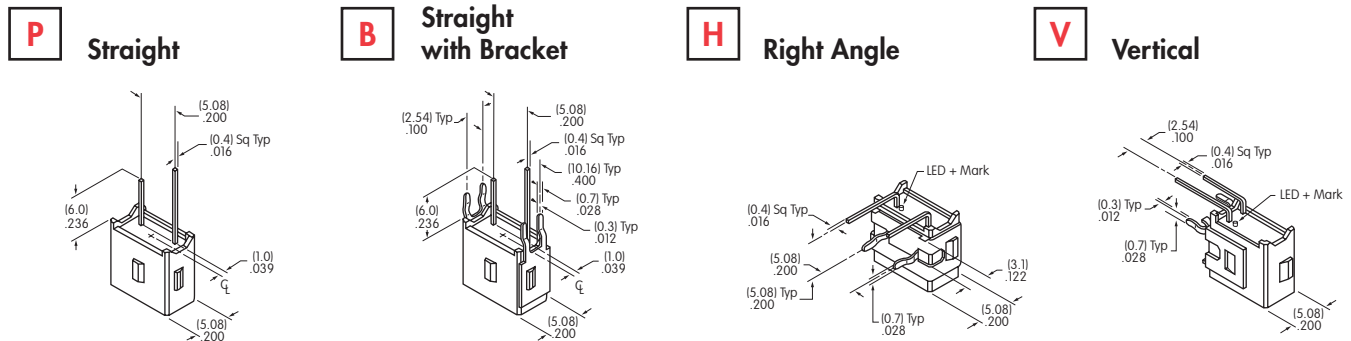

LED COLORS & SPECIFICATIONS

		A01 Indicator		
		C	E	F
Color		Red	Yellow	Green
LED is colored in OFF state	Color	Red	Yellow	Green
Maximum Forward Current	I_{FM}	50mA	50mA	50mA
Typical Forward Current	I_F	30mA	30mA	30mA
Forward Voltage	V_F	1.7V	2.2V	2.1V
Maximum Reverse Voltage	V_{RM}	4V	4V	4V
Current Reduction Rate Above 25°C	ΔI_F	0.67mA/°C	0.67mA/°C	0.67mA/°C
Ambient Temperature Range		-30°C ~ +85°C		

Electrical specifications are determined at a basic temperature of 25°C.
 If the source voltage is greater than the LED's rated voltage, a ballast resistor must be connected in series with the LED.
 The ballast resistor value can be calculated by using the formula shown in the Supplement section.

Toggles
 Rockers
 Pushbuttons
 Illuminated PB
 Programmable
 Keylocks
 Rotaries
 Slides
 Tactiles
 Tilt
 Touch
 Indicators
 Accessories
 Supplement

TYPICAL INDICATOR DIMENSIONS

Straight PC

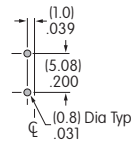
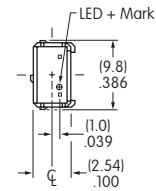
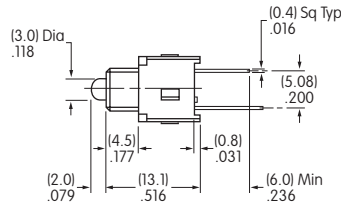
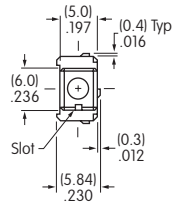

A01PF

Straight PC • Bracket

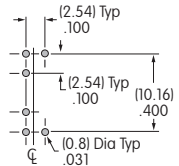
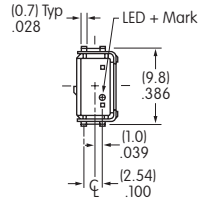
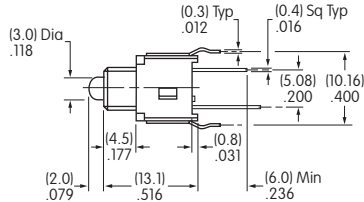
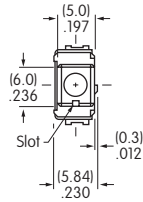

A01BF

Right Angle PC

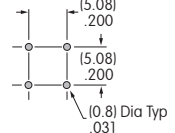
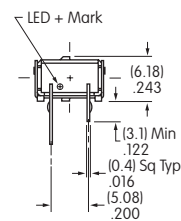
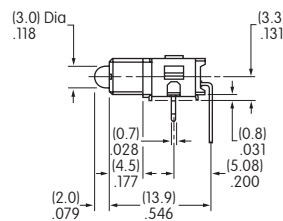
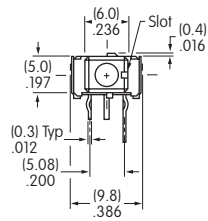

A01HF

Vertical PC

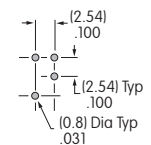
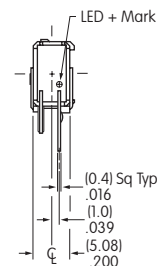
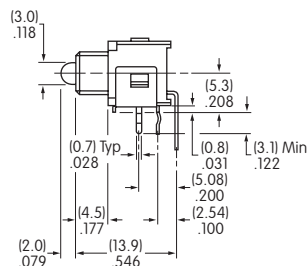
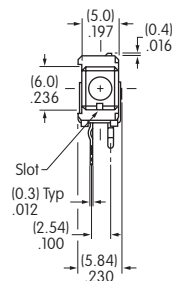

A01VF

Toggles
Rockers
Pushbuttons
Illuminated PB
Programmable
Keylocks
Rotaries
Slides
Tactiles
Tilt
Touch
Indicators
Accessories
Supplement