

Relays & Sockets

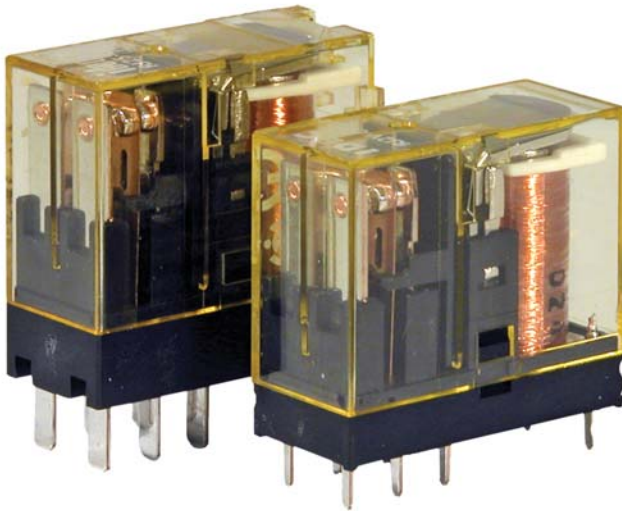

Selection Guide..... 724

General Purpose Relays 726

RH Series Compact Power Relays 726

NEW RJ Series Slim Power Relays..... 736

RO Series PCB Relays 744

RR Series Power Relays..... 748

RU Series Universal Relays 754

RY/RM Series Miniature Relays..... 763

Latching Relays 776

RR2KP Series Latch Relays..... 776

RY2KS Series Latch Relays..... 779

Solid State Relays..... 783

NEW RSC Series DIN Mount SSR..... 783

RSS Series Panel Mount SSR..... 786



Selection Guide

General Purpose Relays

	RH Series	RJ Series	RQ Series	RR Series
Appearance				
Page	726	736	744	748
Contact Configuration	SPDT, DPDT, 3PDT, 4PDT	SPDT, SPST, DPDT, DPST	SPDT, DPDT	SPDT, DPDT, 3PDT
Terminal	Blade or PCB	Blade or PCB	PCB	Pin or Blade
Contact Rating (resistive)	10A, 30V DC/240V AC 1/3HP, 240V AC 1/6HP, 120V AC	SPDT: 12A/16A, 30V DC/250V AC DPDT: 8A, 30V DC/250V AC	SPDT: 12A, 16A DPDT: 8A	10A, 30V DC/ 240V AC 1/3HP, 240V AC 1/4HP, 120V AC
Contact Material	Silver-Cadmium Oxide	Silver-Nickel alloy	Silver-Nickel alloy	Silver

	RU Series	RY/RM Series	
Appearance			
Page	754	763	
Contact Configuration	DPDT, 4PDT	DPDT, 4PDT	DPDT
Terminal	Blade or PCB	Blade or PCB	
Contact Rating (resistive)	DPDT: 10A, 30V DC/250V AC 4PDT: 6A, 30V DC/250V AC 1/10 HP, 240V AC Bifurcated: 3A 250V AC	RY: DPDT: 3A, 30V DC/240V AC 4PDT: 5A, 30V DC/240V AC Bifurcated: 1A 30V DC/120V AC	5A, 30V DC/240V AC
Contact Material	DPDT: Silver Tin Oxide Indium 4PDT: Gold-Silver Alloy on Silver	Standard: Gold plated silver Bifurcated: Palladium Alloy Silver	Silver

Switches & Pilot Lights

Display Lights

Relays & Sockets

Timers

Terminal Blocks



Circuit Breakers

Selection Guide con't

Latching Relays

	RR2KP Series	RY2KS
Appearance		
Page	776	779
Contact Configuration	DPDT	DPDT
Terminal	Pin	Blade
Contact Rating (resistive)	10A, 30V DC 10A, 120V AC	3A, 30V DC 3A, 120V AC
Contact Material	Silver	Silver, gold-plated

Solid State Relays

	RSC Series	RSS Series
Appearance		
Page	783	786
Output Configuration	1 Form A (SPST-NO)	1 Form A (SPST-NO)
Output Rating	20A, 30A, 45A 48 - 600V AC	10A, 25A, 50A, 75A, 90A 48 - 660V AC
Output	Dual SCR (zero crossing)	

Switches & Pilot Lights

Display Lights

Relays & Sockets

Timers

Terminal Blocks

Circuit Breakers

RH Series Compact Power Relays

SPDT through 4PDT, 10A contacts
Compact power type relays

The RH series are miniature power relays with a large capacity. The RH relays feature 10A contact capacity as large as the RR series but in a miniature package. The compact size saves space.

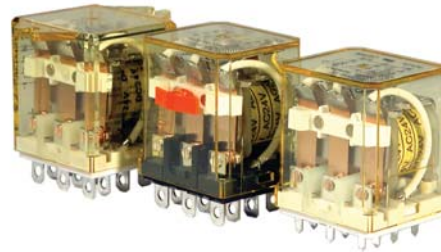

Part Number Selection

Contact	Model	Part Number		Coil Voltage Code <i>(Standard Stock in bold)</i>
		Blade Terminal	PCB Terminal	
 SPDT	Basic	RH1B-U	RH1V2-U	
	With Indicator	RH1B-UL	—	
	With Check Button	RH1B-UC	—	AC6V, AC12V, AC24V , AC110V, AC120V , AC220V, AC240V DC6V, DC12V , DC24V , DC48V, DC110V
	With Indicator and Check Button	RH1B-ULC	—	
	Top Bracket Mounting	RH1B-UT	—	
	With Diode (DC coil only)	RH1B-UD	RH1V2-UD	DC6V, DC12V , DC24V , DC48V, DC110V
	With Indicator and Diode (DC coil only)	RH1B-ULD	—	DC12V , DC24V , DC48V, DC110V
 DPDT	Basic	RH2B-U	RH2V2-U	
	With Indicator	RH2B-UL	RH2V2-UL	AC6V, AC12V, AC24V , AC110-120V , AC220-240V
	With Check Button	RH2B-UC	—	DC6V, DC12V , DC24V , DC48V, DC100-110V
	With Indicator and Check Button	RH2B-ULC	—	
	Top Bracket Mounting	RH2B-UT	—	
	With Diode (DC coil only)	RH2B-UD	RH2V2-UD	DC6V, DC12V , DC24V , DC48V, DC100-110V
	With Indicator and Diode (DC coil only)	RH2B-ULD	—	
 3PDT	Basic	RH3B-U	RH3V2-U	
	With Indicator	RH3B-UL	RH3V2-UL	AC6V, AC12V, AC24V , AC110V, AC120V , AC220V, AC240V DC6V, DC12V , DC24V , DC48V, DC110V
	With Check Button	RH3B-UC	—	
	With Indicator and Check Button	RH3B-ULC	—	
	Top Bracket Mounting	RH3B-UT	—	
	With Diode (DC coil only)	RH3B-D*	RH3V2-D*	DC6V, DC12V, DC24V, DC48V, DC110V
	With Indicator and Diode (DC coil only)	RH3B-LD*	—	
 4PDT	Basic	RH4B-U	RH4V2-U	
	With Indicator	RH4B-UL	RH4V2-UL	AC6V, AC12V, AC24V , AC110V, AC120V , AC220V, AC240V DC6V, DC12V , DC24V , DC48V, DC110V
	With Check Button	RH4B-UC	—	
	With Indicator and Check Button	RH4B-ULC	—	
	Top Bracket Mounting	RH4B-UT	—	
	With Diode (DC coil only)	RH4B-UD	RH4V2-UD	DC6V, DC12V, DC24V, DC48V, DC110V
	With Indicator and Diode (DC coil only)	RH4B-LD*	—	

- 1. *Carries no UL recognition mark.
- 2. PCB terminal relays are designed to mount directly to a circuit board without any socket.

Ordering Information

When ordering, specify the Part No. and coil voltage code:

(example) **RH3B-U** **AC120V**
 Part No. Coil Voltage Code

Sockets (for Blade Terminal Models)

Relays	Standard DIN Rail Mount ¹	Finger-safe DIN Rail Mount ¹	Through Panel Mount	PCB Mount
RH1B	SH1B-05	SH1B-05C	SH1B-51	SH1B-62
RH2B	SH2B-05	SH2B-05C	SH2B-51	SH2B-62
RH3B	SH3B-05	SH3B-05C	SH3B-51	SH3B-62
RH4B	SH4B-05	SH4B-05C	SH4B-51	SH4B-62

1. DIN Rail mount socket comes with two horseshoe clips. Do not use unless you plan to insert pullover wire spring. Replacement horseshoe clip part number is Y778-011.

Hold Down Springs & Clips

Appearance	Description	Relay	For DIN Mount Socket	For Through Panel & PCB Mount Socket	Min Order Qty
	Pullover Wire Spring	RH1B	SY2S-02F1 ²	SY4S-51F1	10
		RH2B	SY4S-02F1 ²		
		RH3B	SH3B-05F1 ²		
		RH4B	SH4B-02F1 ²		
	Leaf Spring (side latch)	RH1B, RH2B, RH3B, RH4B	SFA-202 ³	SFA-302 ³	20
		RH1B, RH2B, RH3B, RH4B	SFA-101 ³	SFA-301 ³	

2. Must use horseshoe clip when mounting in DIN mount socket. Replacement horseshoe clip part number is Y778-011.
3. Two required per relay.

AC Coil Ratings

Voltage (V)	Rated Current (mA) ±15% at 20°C								Coil Resistance (Ω) ±10% at 20°C				Operation Characteristics (against rated values at 20°C)		
	AC 50Hz				AC 60Hz				SPDT	DPDT	3PDT	4PDT	Max. Continuous Applied Voltage	Pickup Voltage	Dropout Voltage
	SPDT	DPDT	3PDT	4PDT	SPDT	DPDT	3PDT	4PDT							
6	170	240	330	387	150	200	280	330	330	9.4	6.4	5.4			
12	86	121	165	196	75	100	140	165	165	39.3	25.3	21.2			
24	42	60.5	81	98	37	50	70	83	83	153	103	84.5			
110	9.6	—	18.1	21.6	8.4	—	15.5	18.2	18.2	—	2,200	1,800			
110-120	—	9.4-10.8	—	—	—	8.0-9.2	—	—	—	—	—	—			
120	8.6	—	16.4	19.5	7.5	—	14.2	16.5	16.5	—	10,800	7,360			
220	4.7	—	8.8	10.7	4.1	—	7.7	9.1	9.1	—	10,800	7,360			
220-240	—	4.7-5.4	—	—	—	4.0-4.6	—	—	—	18,820	—	—			
240	4.9	—	8.2	9.8	4.3	—	7.1	8.3	8.3	—	12,100	9,120			

DC Coil Ratings

Voltage (V)	Rated Current (mA) ±15% at 20°C				Coil Resistance (Ω) ±10% at 20°C				Operation Characteristics (against rated values at 20°C)		
	SPDT	DPDT	3PDT	4PDT	SPDT	DPDT	3PDT	4PDT	Max. Continuous Applied Voltage	Pickup Voltage	Dropout Voltage
6	128	150	240	250	47	40	25	24	110%	80% maximum	10% minimum
12	64	75	120	125	188	160	100	96			
24	32	36.9	60	62	750	650	400	388			
48	18	18.5	30	31	2,660	2,600	1,600	1,550			
100-110	—	8.2-9.0	—	—	—	12,250	—	—			
110	8	—	12.8	15	13,800	—	8,600	7,340			

Standard coil voltages are in **BOLD**.

Contact Ratings

Maximum Contact Capacity						
Model	Continuous Current	Allowable Contact Power		Rated Load		
		Resistive Load	Inductive Load	Voltage (V)	Res. Load	Ind. Load
SPDT	10A	1540VA 300W	990VA 210W	110 AC	10A	7A
				220 AC	7A	4.5A
				30 DC	10A	7A
DPDT 3PDT 4PDT	10A	1650VA 300W	1100VA 225W	110 AC	10A	7.5A
				220 AC	7.5A	5A
				30 DC	10A	7.5A

Note: Inductive load for the rated load — $\cos \phi = 0.3$, L/R = 7 ms



TÜV Ratings

Voltage	RH1	RH2	RH3	RH4
240V AC	10A	10A	7.5A	7.5A
30V DC	10A	10A	10A	10A

AC: $\cos \phi = 1.0$, DC: L/R = 0 ms



Socket Specifications

	Sockets	Terminal	Electrical Rating	Wire Size	Torque
DIN Rail Mount Sockets	SH1B-05	(Coil) M3 screws (contact) M3.5 screws with captive wire clamp	250V, 10A	Maximum up to 2-#12AWG	5.5 - 9 in•lbs 9 - 11.5 in•lbs
	SH2B-05 SH3B-05 SH4B-05	M3.5 screws with captive wire clamp	300V, 10A	Maximum up to 2-#12AWG	9 - 11.5 in•lbs
Finger-safe DIN Rail Mount	SH1B-05C	(coil) M3 screws (contact) M3.5 screws with captive wire clamp, fingersafe	250V, 10A	Maximum up to 2-#12AWG	5.5 - 9 in•lbs 9 - 11.5 in•lbs
	SH2B-05C SH3B-05C SH4B-05C	M3.5 screws with captive wire clamp, fingersafe	300V, 10A	Maximum up to 2-#12AWG	9 - 11.5 in•lbs
Through Panel Mount Socket	SH1B-51 SH2B-51 SH3B-51 SH4B-51	Solder	300V, 10A	—	—
PCB Mount Socket	SH1B-62	PCB mount	250V, 10A	—	—
	SH2B-62 SH3B-62 SH4B-62	PCB mount	300V, 10A	—	—

Accessories

Description	Appearance	Use with	Part No.	Remarks
Aluminum DIN Rail (1 meter length)		All DIN rail sockets	BNDN1000	IDEC offers a low-profile DIN rail (BNDN1000). The BNDN1000 is designed to accommodate DIN mount sockets. Made of durable extruded aluminum, the BNDN1000 measures 0.413 (10.5mm) in height and 1.37 (35mm) in width (DIN standard). Standard length is 39" (1,000mm).
DIN Rail End Stop		DIN rail	BNL5	9.1 mm wide.
Replacement Hold-Down Spring Anchor		DIN mount sockets and hold down springs.	Y778-011	For use on DIN rail mount socket when using pullover wire hold down spring. 2 pieces included with each socket.

UL Ratings

Voltage	Resistive			General Use			Horse Power Rating		
	RH1 RH2	RH3	RH4	RH1 RH2	RH3	RH4	RH1 RH2	RH3	RH4
240V AC	10A	7.5A	7.5A	7A	6.5A	5A	1/3 HP	1/3 HP	—
120V AC	—	10A	10A	—	7.5A	7.5A	1/6 HP	1/6 HP	—
30V DC	10A	10A	—	7A	—	—	—	—	—
28V DC	—	—	10A	—	—	—	—	—	—

CSA Ratings

Voltage	Resistive				General Use				Horse Power Rating
	RH1	RH2	RH3	RH4	RH1	RH2	RH3	RH4	RH1, 2, 3
240V AC	10A	10A	—	7.5A	7A	7A	7A	5A	1/3 HP
120V AC	10A	10A	10A	10A	7.5A	7.5A	—	7.5A	1/6 HP
30V DC	10A	10A	10A	10A	7A	7.5A	—	—	—

Switches & Pilot Lights

Display Lights

Relays & Sockets

Timers

Terminal Blocks

Circuit Breakers

Specifications

Contact Material	Silver cadmium oxide		
Contact Resistance ¹	50mΩ maximum		
Minimum Applicable Load	24V DC, 30 mA; 5V DC, 100 mA (reference value)		
Operate Time ²	SPDT DPDT	20ms maximum	
	3PDT 4PDT	25ms maximum	
Release Time ²	SPDT DPDT	20ms maximum	
	3PDT 4PDT	25ms maximum	
Power Consumption (approx.)	SPDT	AC: 1.1VA (50Hz), 1VA (60Hz)	DC: 0.8W
	DPDT	AC: 1.4VA (50Hz), 1.2VA (60Hz)	DC: 0.9W
	3PDT	AC: 2VA (50Hz), 1.7VA (60Hz)	DC: 1.5W
	4PDT	AC: 2.5VA (50Hz), 2VA (60Hz)	DC: 1.5W
Insulation Resistance	100MΩ minimum (500V DC megger)		
Dielectric Strength ³	SPDT	Between live and dead parts:	2,000V AC, 1 minute
		Between contact and coil:	2,000V AC, 1 minute
		Between contacts of the same pole:	1,000V AC, 1 minute
	DPDT 3PDT 4PDT	Between live and dead parts:	2,000V AC, 1 minute
	Between contact and coil:	2,000V AC, 1 minute	
	Between contacts of different poles:	2,000V AC, 1 minute	
	Between contacts of the same pole:	1,000V AC, 1 minute	
Operating Frequency	Electrical:	1,800 operations/hour maximum	
	Mechanical:	18,000 operations/hour maximum	
Vibration Resistance	Damage limits:	10 to 55Hz, amplitude 0.5 mm	
	Operating extremes:	10 to 55Hz, amplitude 0.5 mm	
Shock Resistance	Damage limits:	1,000m/s ² (100G)	
	Operating extremes:	200m/s ² (20G - SPDT, DPDT) 100m/s ² (10G - 3PDT, 4PDT)	
Mechanical Life	50,000,000 operations minimum		
Electrical Life	DPDT	500,000 operations minimum (120V AC, 10A)	
	SPDT 3PDT 4PDT	200,000 operations minimum (120V AC, 10A)	
	SPDT	-25 to +50°C (no freezing)	
	DPDT 3PDT 4PDT	-25 to +40°C (no freezing)	
Operating Humidity	45 to 85% RH (no condensation)		
Weight (approx.)	SPDT: 24g, DPDT: 37g, 3PDT: 50g, 4PDT: 74g		



Note: Above values are initial values.

1. Measured using 5V DC, 1A voltage drop method
2. Measured at the rated voltage (at 20°C), excluding contact bouncing
Release time of relays with diode: 40 ms maximum
3. Relays with indicator or diode: 1000V AC, 1 minute
4. For use under different temperature conditions, refer to Continuous Load Current vs. Operating Temperature Curve. The operating temperature range of relays with indicator or diode is -25 to +40°C.

Characteristics (Reference Data)

Electrical Life Curves

AC Load

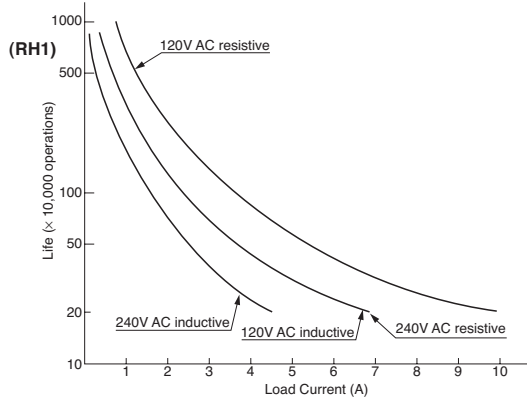

DC Load

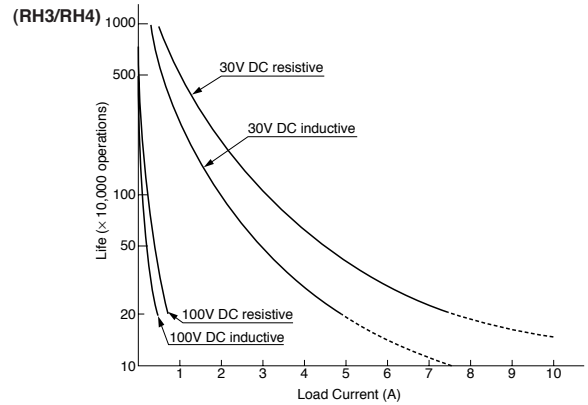
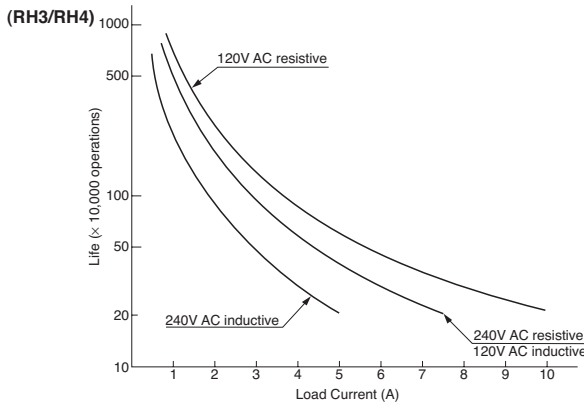
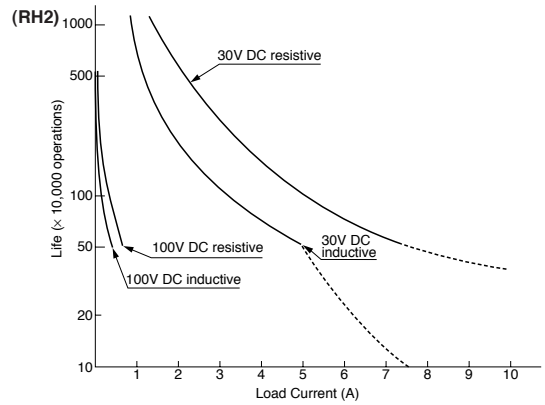
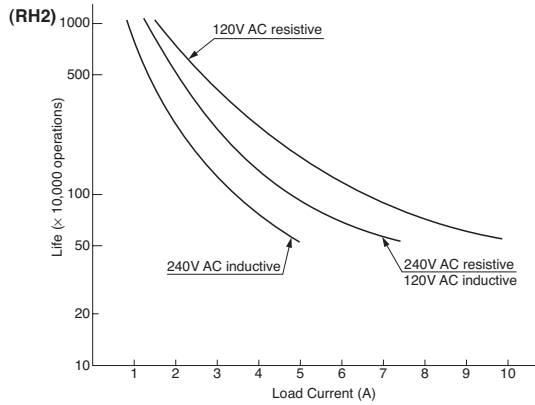
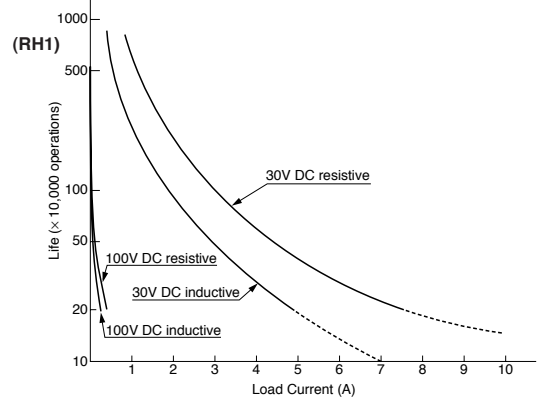

Maximum Switching Capacity

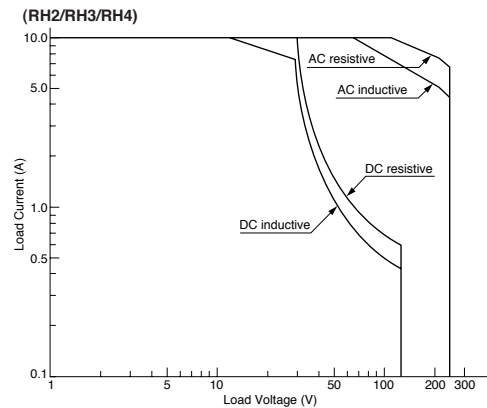
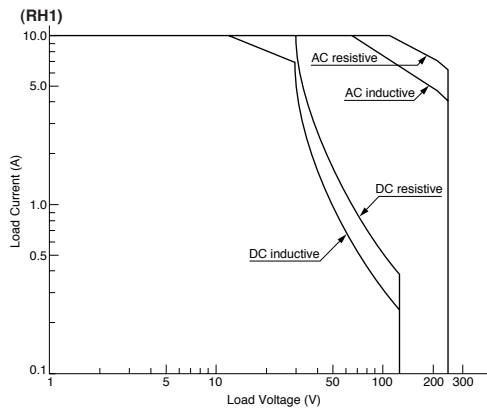

Switches & Pilot Lights

Display Lights

Relays & Sockets

Timers

Terminal Blocks

Circuit Breakers

Continuous Load Current vs. Operating Temperature Curve (Basic Type, With Check Button, and Top Bracket Mounting Type)

(RH1)

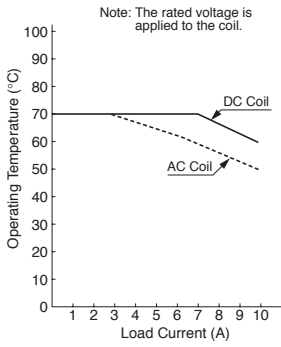

(RH2)

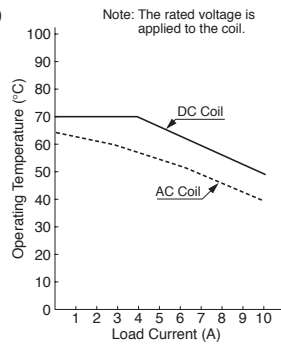

(RH3/RH4)

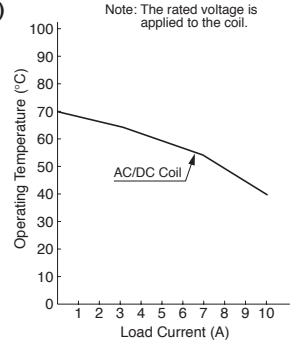

Internal Connection (View from Bottom)

Basic Type

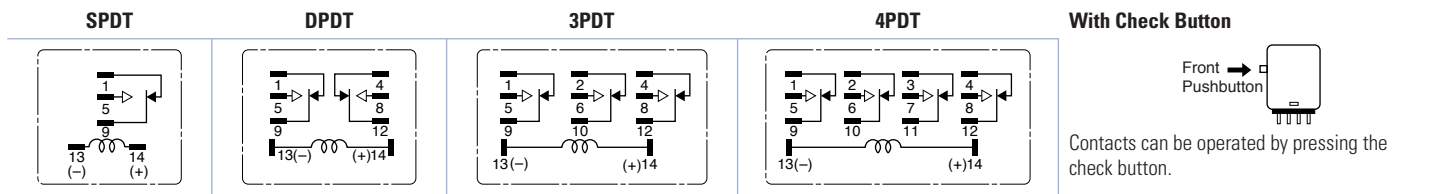

With Indicator (-L type)

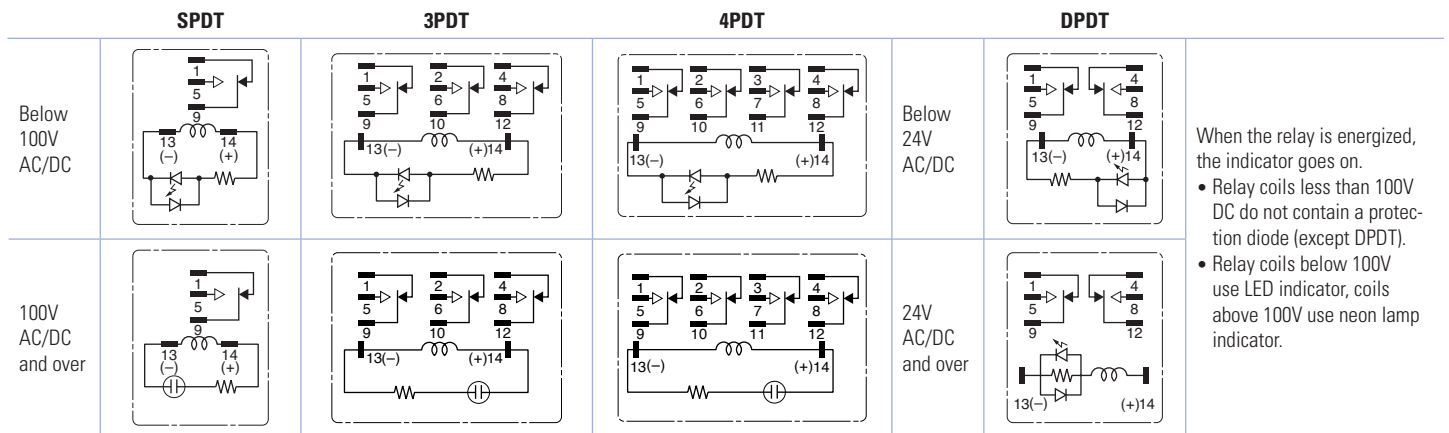

With Diode (-D type)

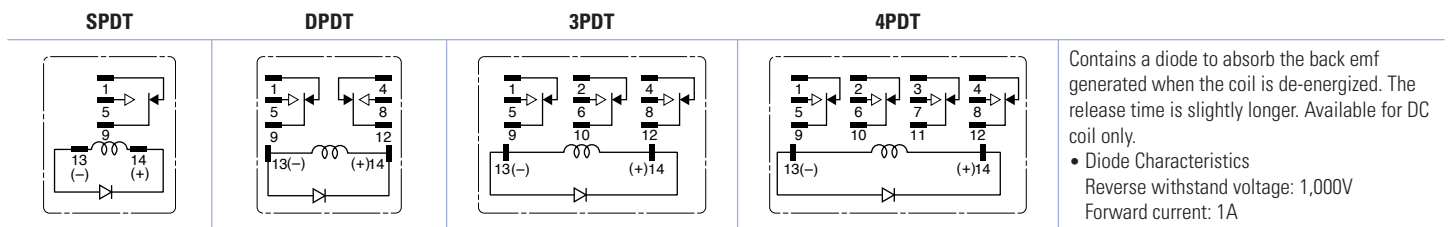

With Indicator LED & Diode (-LD type)

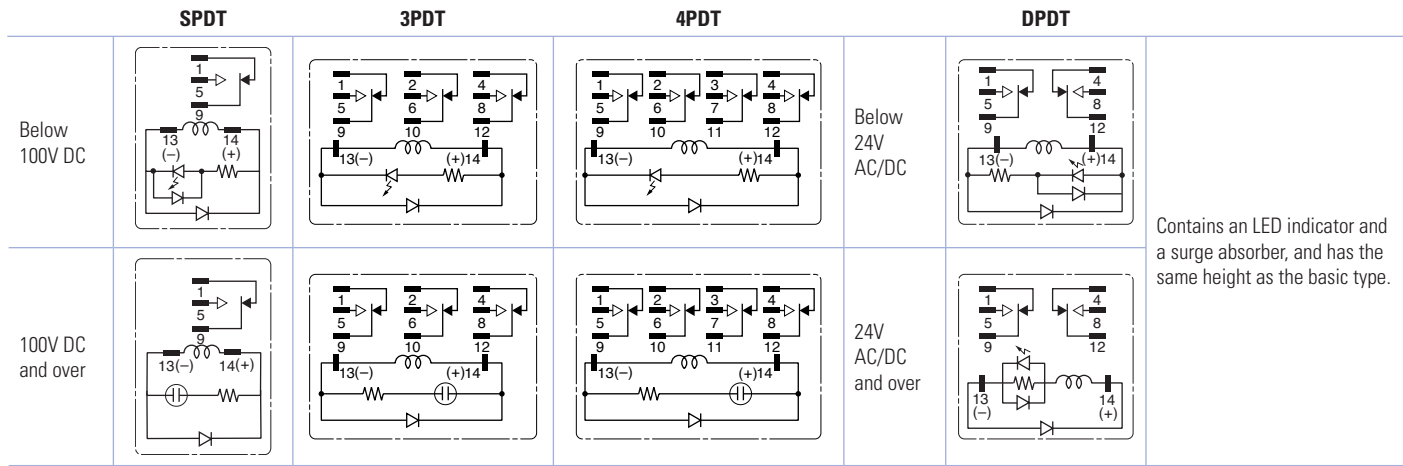

Dimensions (mm)

RH1B-U/RH1B-UL/RH1B-UD/RH1B-ULD

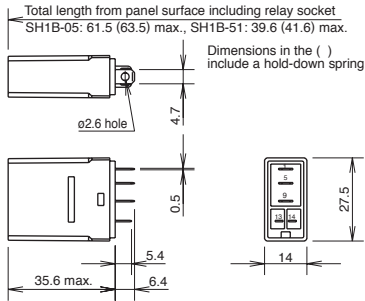

RH2B-U/RH2B-UL/RH2B-UD/RH2B-ULD

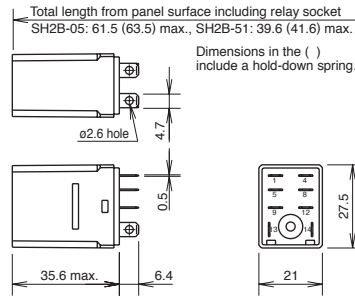

RH3B-U/RH3B-UL/RH3B-D/RH3B-LD

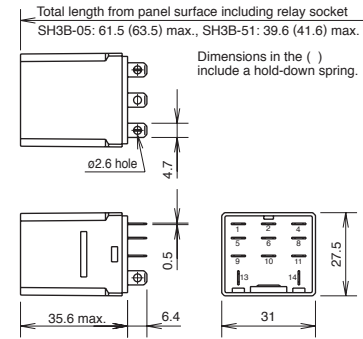

RH4B-U/RH4B-UL/RH4B-UD/RH4B-LD

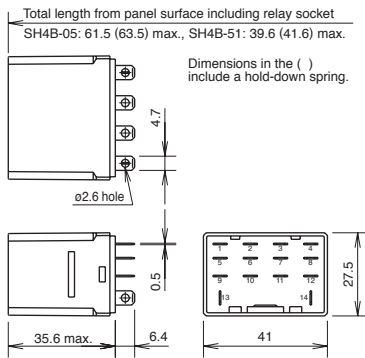

RH1B-UT

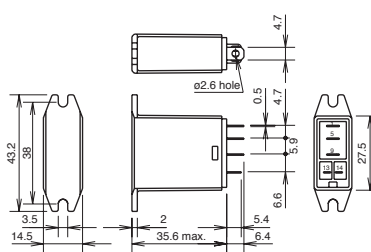

RH2B-UT

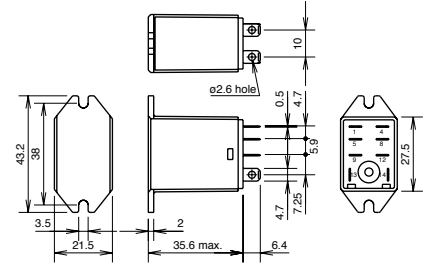

RH3B-UT

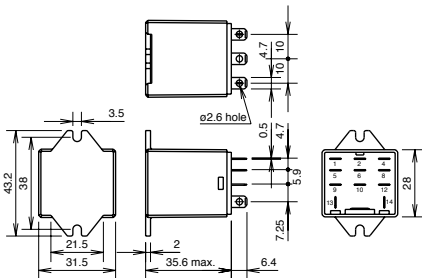

RH4B-UT

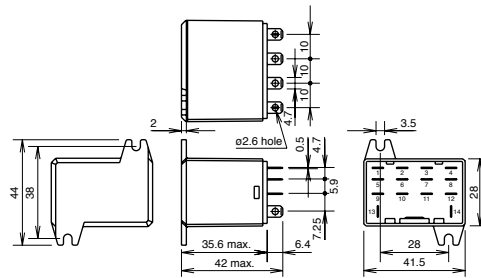

Switches & Pilot Lights

Display Lights

Relays & Sockets

Timers

Terminal Blocks

Circuit Breakers

Dimensions con't (mm)

RH1V2-U/RH1V2-UD

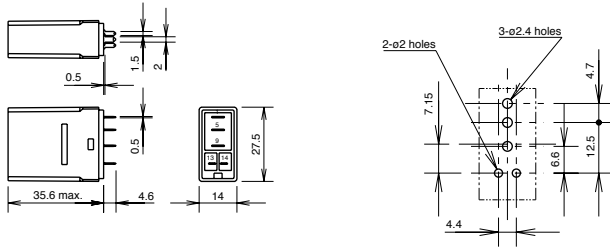

RH2V2-U/RH2V2-UL/RH2V2-UD

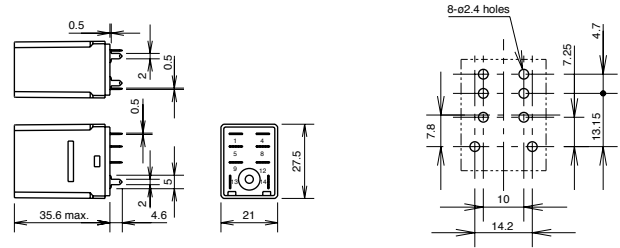

RH3V2-U/RH3V2-UL/RH3V2-D

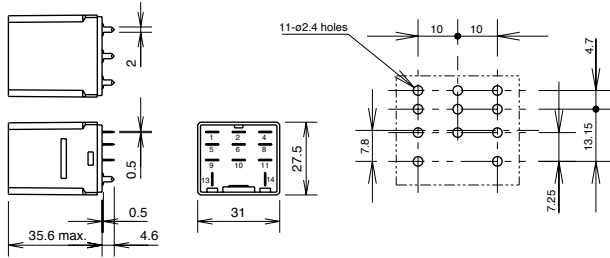

RH4V2-U/RH4V2-UL/RH4V2-UD

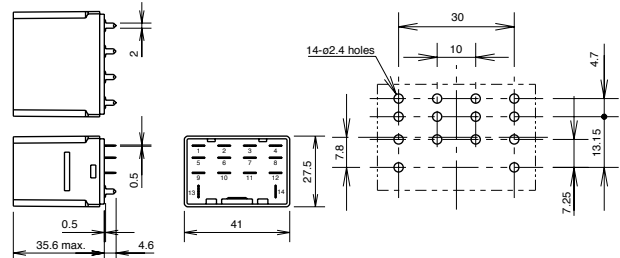

Standard DIN Rail Mount Sockets

SH1B-05

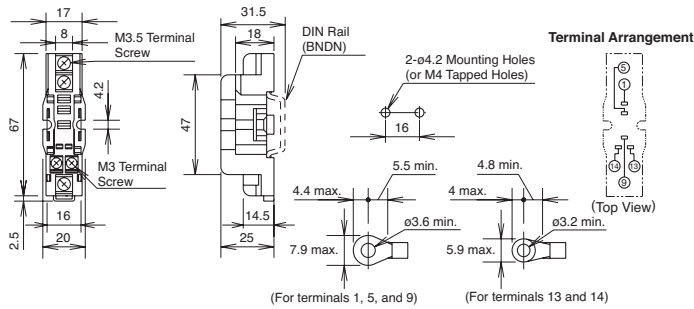

SH2B-05

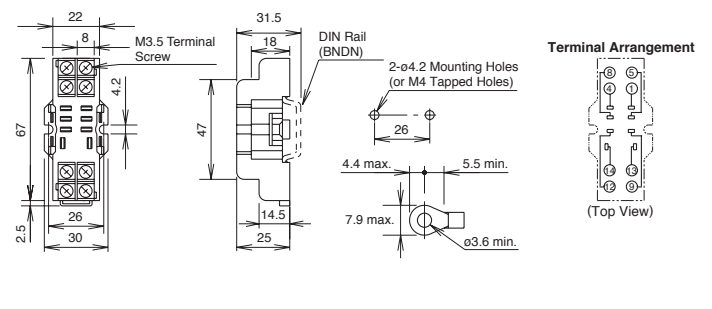

SH3B-05

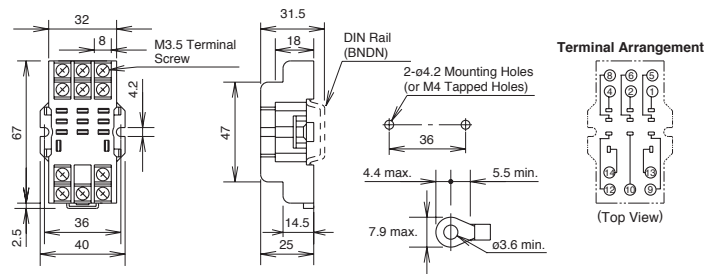

SH4B-05

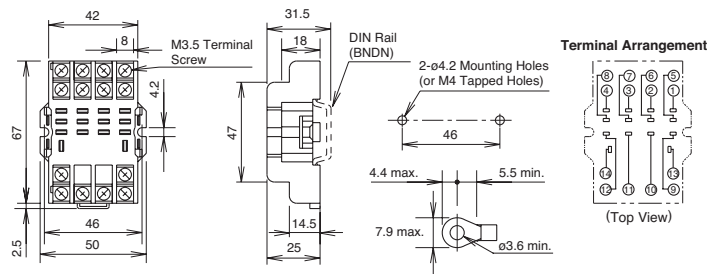

Dimensions con't (mm)

Finger-safe DIN Rail Mount Sockets

SH1B-05C

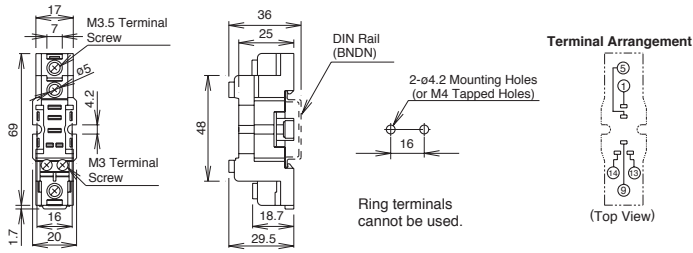

SH2B-05C

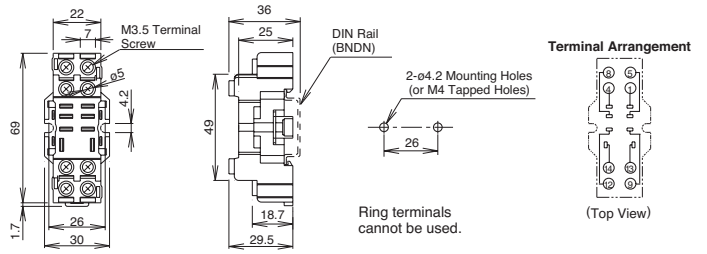

SH3B-05C

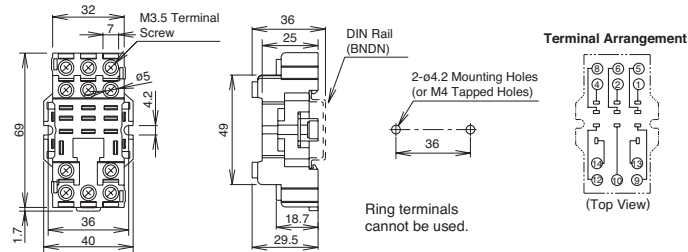

SH4B-05C

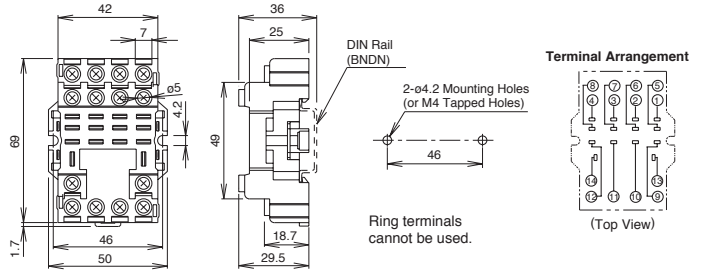

Through Panel Mount Socket

SH1B-51

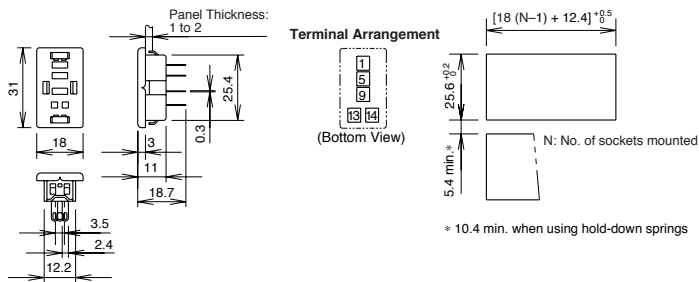

SH2B-51

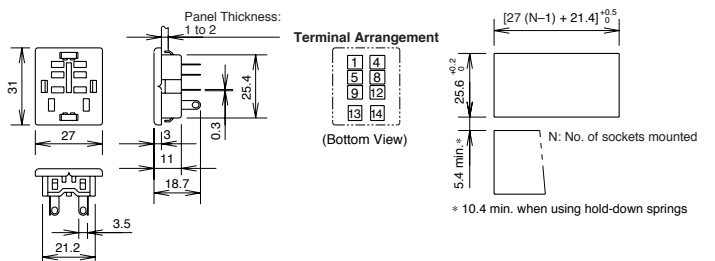

SH3B-51

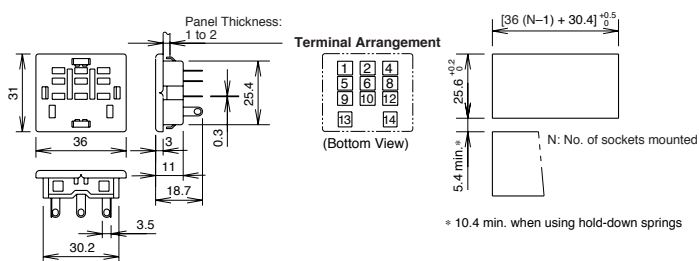

SH4B-51

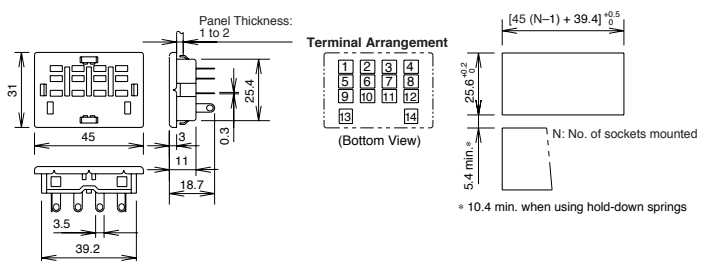

Switches & Pilot Lights

Display Lights

Relays & Sockets

Timers

Terminal Blocks

Circuit Breakers

Dimensions con't (mm)

PCB Mount Sockets

SH1B-62

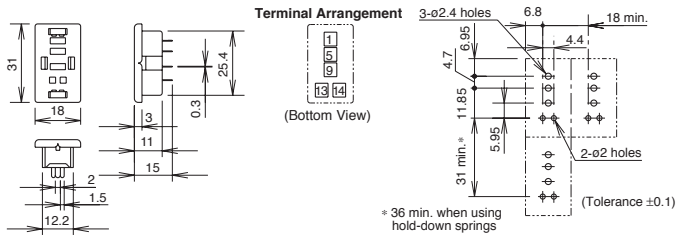

SH2B-62

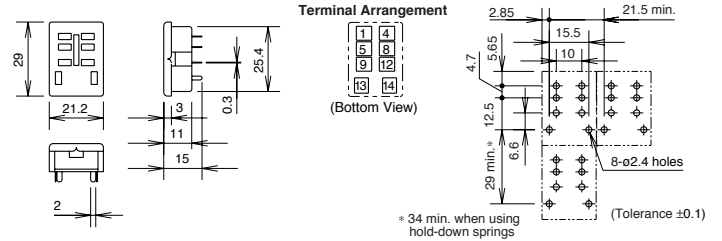

SH3B-62

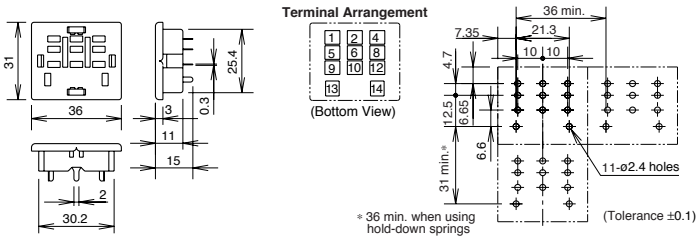

SH4B-62

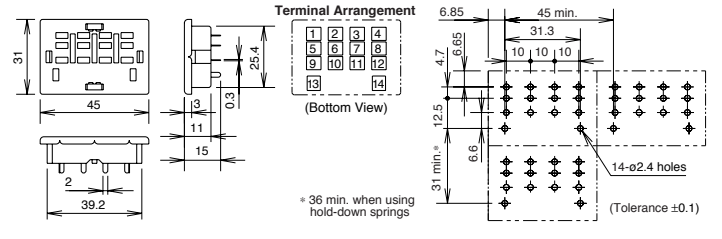

Switches & Pilot Lights

Display Lights

Relays & Sockets

Timers

Terminal Blocks

Circuit Breakers

RJ Series Slim Power Relays

Compact and rugged power relays. Large switching capacity.

- Compact housing only 12.7-mm wide.
Large contact rating
RJ1 (1-pole): 16A (UL general use rating @250V AC)
RJ2 (2-pole): 8A
- Non-polarized LED indicator available on blade type. IDEC's unique light guide structure enables high visibility of coil status from any direction.
- Excellent electrical and mechanical life.
Electrical life: 200,000 operations (AC load)
Mechanical life: 30 million operations (AC coil)
- RoHS directive compliant (EU directive 2002/95/EC). Contains no lead, cadmium, mercury, hexavalent chromium, PBB or PBDE).
- Diode model:
Diode reverse withstand voltage: 1000V
- UL recognized, CSA certified, EN compliant.



UL508
UL File No. E55996



CSA C22.2 No. 14
1608322
CSA File No. LR35144





EN61810-1
VDE (REG.-Nr B312)



EN61810-1
EC Low Voltage Directive

Part Number Selection

	Terminal	Contact	Model	Part Number	Coil Voltage Code (Standard Stock in bold)
	Blade	SPDT	Standard	RJ1S-C-	A24 , A110, A120 , A220, A240 , D12, D24 , D48, D100
			with LED	RJ1S-CL-	D12, D24 , D48, D100
			with Surge Suppression Diode	RJ1S-CD-	
			with LED & Surge Suppression Diode	RJ1S-CLD-	
		DPDT	Standard	RJ2S-C-	A24 , A110, A120 , A220, A240 , D12, D24 , D48, D100
			with LED	RJ2S-CL-	D12, D24 , D48, D100
			with Surge Suppression Diode	RJ2S-CD-	
			with LED & Surge Suppression Diode	RJ2S-CLD-	
	PCB	SPDT	Standard	RJ1V-C-	A24 , A110, A120 , A220, A240 , D5, D6, D12, D24 , D48, D100
			High Capacity	RJ1V-CH-	
		SPST-NO	Standard	RJ1V-A-	
			High Capacity	RJ1V-AH-	
		DPDT	Standard	RJ2V-C-	
		DPST-NO	Standard	RJ2V-A-	

Ordering Information

When ordering, specify the Part No. and coil voltage code:

(example) **RJ1S-C-** **A120**
Part No. Coil Voltage Code

Coil Voltage Table

Coil Voltage Code	A12	A24	A110	A120	A220	A240	D5	D6	D12	D24	D48	D100
Coil Rating	12V AC	24V AC	110V AC	120V AC	220V AC	240V AC	5V DC	6V DC	12V DC	24V DC	48V DC	100-110V DCV DC

Switches & Pilot Lights

Display Lights

Relays & Sockets

Timers

Terminal Blocks

Circuit Breakers

Sockets

	Relays	Standard DIN Rail Mount	Finger-safe DIN Rail Mount	PCB Mount
Blade Models	RJ1S (Std)	SJ1S-05B	SJ1S-07L	SJ1S-61
	RJ2S (Std)	SJ2S-05B	SJ2S-07L	SJ2S-61
PCB Models	RJ1V (Std)	—	SQ1V-07B*	SQ1V-63*
	RJ1V (HC) RJ2V	—	SQ2V-07B*	SQ2V-63*



*Hold-down clip or spring must be removed to use with RJ PCB relays.

Replacement Hold Down Springs

Part Number	Used With Socket
SJ9Z-C1	SJ1S-05B, SJ1S-07L, SJ2S-05B, SJ2S-07L
SQ9Z-C	SQ1V-07B, SQ2V-07B
SQ9Z-C63	SQ1V-63, SQ2V-63

Jumpers for SJ Sockets

Poles	Part Number	Quantity
2	SJ9Z-JF2	Must purchase in quantities of 10.
5	SJ9Z-JF5	
8	SJ9Z-JF8	
10	SJ9Z-JF10	

Accessories

Description	Appearance	Use with	Part No.	Remarks
Aluminum DIN Rail (1 meter length)		All DIN rail sockets	BNDN1000	IDEC offers a low-profile DIN rail (BNDN1000). The BNDN1000 is designed to accommodate DIN mount sockets. Made of durable extruded aluminum, the BNDN1000 measures 0.413 (10.5mm) in height and 1.37 (35mm) in width (DIN standard). Standard length is 39" (1,000mm).
DIN Rail End Stop		DIN rail	BNL5	9.1 mm wide.

Specifications

Model	RJ1	RJ2
Number of Poles	1-pole	2-pole
Contact Configuration	SPDT	DPDT
Contact Material	Silver-nickel alloy	
Degree of Protection	IP40	
Contact Resistance (initial value) (*1)	50 mΩ maximum	
Operate Time (*2)	15 ms maximum	
Release Time (*2)	10 ms maximum (with diode: 20 ms maximum)	
Dielectric Strength	Between contact and coil	5000V AC, 1 minute
	Between contacts of the same pole	1000V AC, 1 minute
	Between contacts of different poles	—
Vibration Resistance	Operating extremes	10 to 55 Hz, amplitude 0.75 mm
	Damage limits	10 to 55 Hz, amplitude 0.75 mm
Shock Resistance	Operating extremes	NO contact: 200 m/s ² , NC contact: 100 m/s ²
	Damage limits	1000 m/s ²
Electrical Life (rated load)	AC load: 200,000 operations minimum (operation frequency 1800 operations per hour) DC load: 100,000 operations minimum (operation frequency 1800 operations per hour)	
Mechanical Life (no load)	AC coil: 30,000,000 operations minimum (operation frequency 18,000 operations per hour) DC coil: 50,000,000 operations minimum (operation frequency 18,000 operations per hour)	
Operating Temperature (*3)	-40 to +70°C (no freezing)	
Operating Humidity	5 to 85% RH (no condensation)	
Weight (approx.)	19g (blade type), 17g (PCB form C type), 16g (PCB form A type)	



Note: Above values are initial values.
 1. Measured using 5V DC, 1A voltage drop method.
 2. Measured at the rated voltage (at 20°C), excluding contact bounce time.
 3. 100% rated voltage.

Coil Ratings

Rated Voltage			Coil Voltage Code	Rated Current (mA) ±15% (at 20°C)				Coil Resistance (ohms)±10% (at 20°C)	Operating Characteristics ²			Power Consumption	
				Without LED ¹		With LED ¹			Pickup Voltage	Dropout Voltage	Maximum Allowable Voltage ³		
				50Hz	60Hz	50Hz	60Hz						
AC	Blade & PCB Models	24V	A24	43.9	37.5	47.5	41.1	243	80% max	30% min	140%	0.9VA (60Hz)	
		120V	A120	8.8	7.5	8.7	7.4						6,400
		240V	A240	4.3	3.7	4.3	3.7						25,570
Rated Voltage			Coil Voltage Code	Rated Current (mA) ±15% (at 20°C)				Coil Resistance (ohms)±10% (at 20°C)	Operating Characteristics ²			Power Consumption	
				Without LED ¹		With LED ¹			Pickup Voltage	Dropout Voltage	Maximum Allowable Voltage ³		
				50Hz	60Hz	50Hz	60Hz						
DC	Blade Models	12V	D12	44.2		48.0		271	70% max	10% min	170%	0.53W	
		24V	D24	22.1		25.7		1,080					
		48V	D48	11.0		10.7		4,340					
		100-110V	D100	5.3 - 5.8		5.2 - 5.7		18,870			160%		
	PCB Models	5V	D5	106		-		47.2	70% max	10% min	170%		
		6V	D6	88.3		-		67.9					
		12V	D12	44.2		-		271					
		24V	D24	22.1		-		1,080					
		48V	D48	11.0		-		4,340					
		100-110V	D100	5.3 - 5.8		-		18,870			160%		

1. LED Indicator is only available on Blade relays.
2. Operating characteristics are at 20°C.
3. The maximum allowable voltage is the maximum value which can be applied to the relay coils.

Contact Ratings

Model	Contact	Allowable Contact Power		Rated Load			Allowable Switching Current	Allowable Switching Voltage	Minimum Applicable Load		
		Resistive Load	Inductive Load	Voltage	Resistive Load	Inductive Load cosφ=0.3 L/R=7ms					
Blade Models	1 pole	NO	3000V AC	1875VA	250V AC	12A	7.5A	16A	AC250V	DC5V	
		NC	3000V AC	1875VA	250V AC	12A	7.5A	6A	DC30V	100mA	
	2 poles	NO	2000V AC	1000VA	250V AC	8A	4A	4A	AC250V	DC5V	
		NC	2000V AC	1000VA	250V AC	8A	4A	4A	DC30V	100mA	
PCB Models	1 pole	Standard Type	NO	3000V AC	1875VA	250V AC	12A	7.5A	12A	AC250V	DC5V
			NC	3000V AC	1875VA	250V AC	12A	7.5A			
		High Capacity Type	NO	400V AC	2000VA	250V AC	16A	8A	16A	AC250V	
			NC	400V AC	2000VA	250V AC	16A	8A			
			NO	480W	240W	30V DC	16A	8A	8A	AC250V	
			NC	400V AC	2000VA	250V AC	16A	8A			
	2 poles	NO	2000V AC	1000VA	250V AC	8A	4A	8A	AC250V		
		NC	2000V AC	1000VA	250V AC	8A	4A			4A	DC125V
		NO	240W	120W	30V DC	8A	4A	8A	AC250V		
		NC	2000V AC	1000VA	250V AC	8A	4A			4A	DC125V
NO	120W	60W	30V DC	4A	2A	4A	AC250V				
NC	2000V AC	1000VA	250V AC	8A	4A			4A	DC125V		

Agency Ratings

Voltage	UL				CSA								VDE			
	General Use				Resistive				Inductive				Resistive		AC-15, DC-13*	
	RJ1		RJ2		RJ1		RJ2		RJ1		RJ2		RJ1	RJ2	RJ1	RJ2
	NO	NC	NO	NC	NO	NC	NO	NC	NO	NC	NO	NC	NO	NO	NO	NO
250V AC	16A	6A	8A	4A	12A	12A	8A	8A	7.5A	7.5A	4A	4A	12A	8A	6A	3A
30V DC	12A	6A	8A	4A	12A	6A	8A	4A	6A	3A	4A	2A	12A	8A	2.5A	2A

*According to the utilization categories of IEC60947-5-1

Switches & Pilot Lights

Display Lights

Relays & Sockets

Timers

Terminal Blocks

Circuit Breakers

Socket Specifications

	Socket	Terminal	Electrical Rating	Wire Size	Torque
DIN Rail/ Panel Mount	SJ1S-05B	M3 screw with captive wire clamp	250V, 12A	Maximum up to 2 - #14 AWG	0.6 - 1.0N•m (Maximum 1.2N•m)
	SJ2S-05B	M3 screw with captive wire clamp	250V, 8A	Maximum up to 2 - #14 AWG	0.6 - 1.0N•m (Maximum 1.2N•m)
Finger-safe DIN Rail/ Panel Mount	SJ1S-07L	M3 screw with captive wire clamp, fingersafe	250V, 12A	Maximum up to 2 - #14 AWG	0.6 - 1.0N•m (Maximum 1.2N•m)
	SJ2S-07L	M3 screw with captive wire clamp, fingersafe	250V, 8A	Maximum up to 2 - #14 AWG	0.6 - 1.0N•m (Maximum 1.2N•m)
	SQ1V-07B	M3 screw with box clamp, fingersafe	300V, 12A	Maximum up to 2 - #14 AWG	1.0N•m Maximum
	SQ2V-07B	M3 screw with box clamp, fingersafe	300V, 10A	Maximum up to 2 - #14 AWG	1.0N•m Maximum
PCB Mount	SJ1S-61	PCB mount	250V, 12A	—	—
	SJ2S-61	PCB mount	250V, 8A	—	—
	SQ1V-63	PCB mount	300V, 12A	—	—
	SQ2V-63	PCB mount	300V, 12A	—	—

Switches & Pilot Lights

Display Lights

Electrical Life Curve (Resistive Load)

RJ1

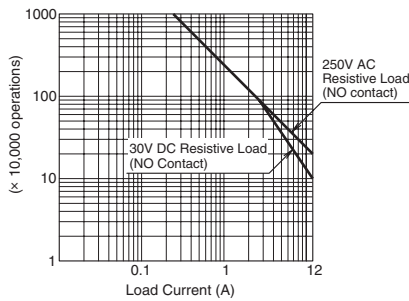

RJ1 High Capacity

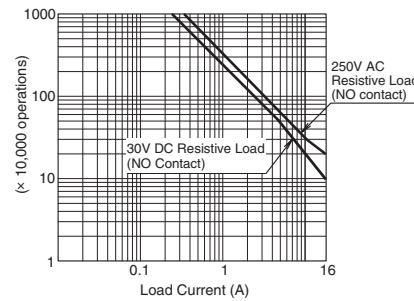

RJ2

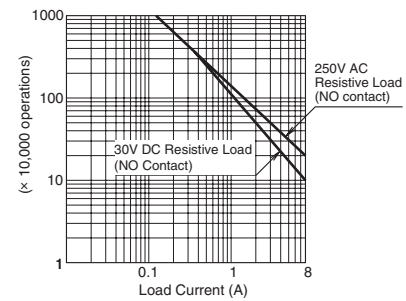

Relays & Sockets

Maximum Switching Capacity (Resistive Load)

RJ1

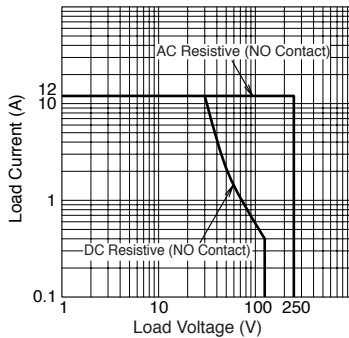

RJ1 High Capacity

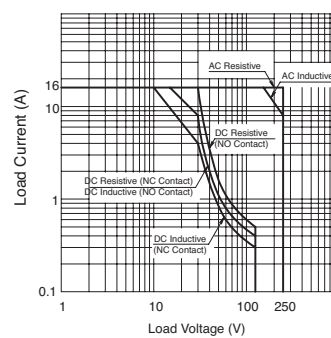

RJ2

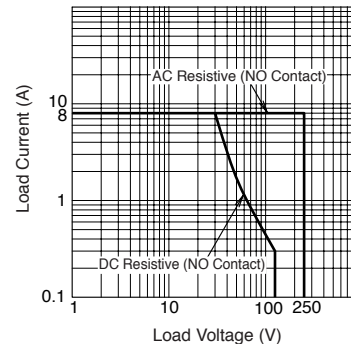

Timers

Terminal Blocks

Circuit Breakers

Operating Temperature and Coil Temperature Rise

RJ1 (AC Coil, 60 Hz)

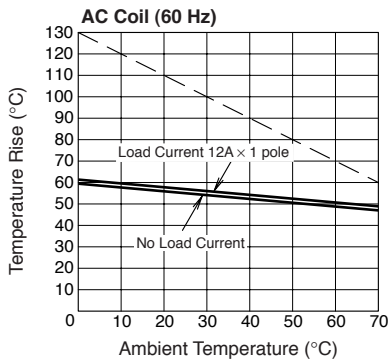

RJ1 (AC Coil, 50 Hz)

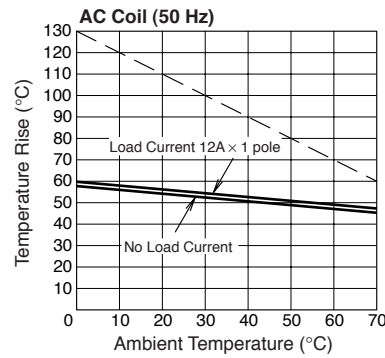

RJ1 (DC Coil)

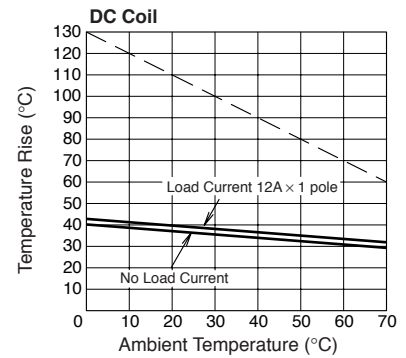

RJ2 (AC Coil, 60 Hz)

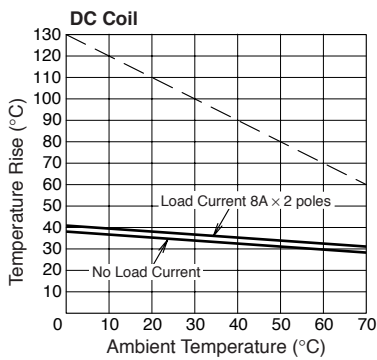

RJ2 (AC Coil, 50 Hz)

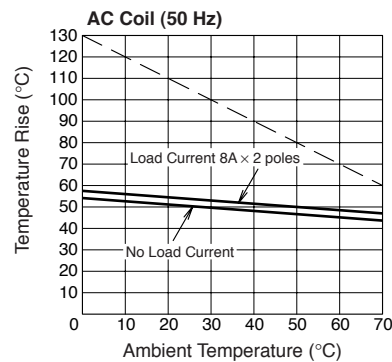

RJ2 (DC Coil)

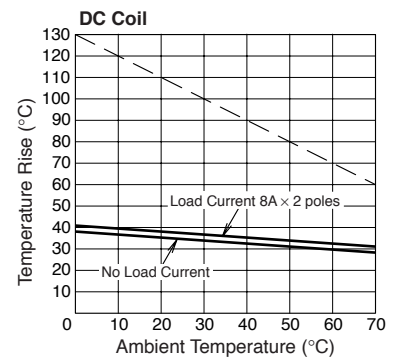

The above temperature rise curves show characteristics when 100% the rated coil voltage is applied. The slanted dashed line indicates allowable temperature rise for the coil at different ambient temperatures.

Internal Connection (View from Bottom)

RJ1S-C-* Standard

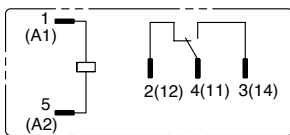

RJ2S-C-* Standard

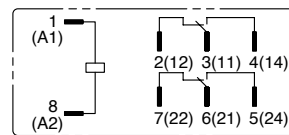

RJ1S-CL-* With LED Indicator

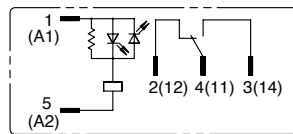
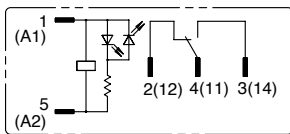

Coil voltage 24V AC/DC and below

Coil voltage greater than 24V AC/DC

RJ2S-CL-* With LED Indicator

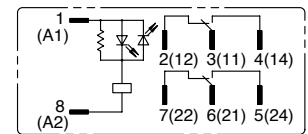
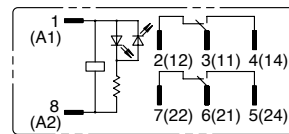

Coil voltage 24V AC/DC and below

Coil voltage greater than 24V AC/DC

RJ1S-CD-* With Diode

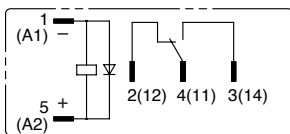

RJ2S-CD-* With Diode

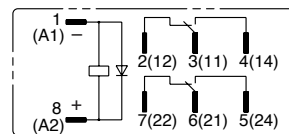

RJ1S-CLD-* With LED Indicator and Diode

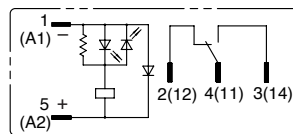
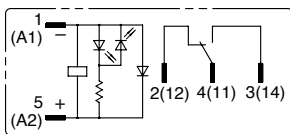

Coil voltage 24V DC and below

Coil voltage greater than 24V DC

RJ2S-CLD-* With LED Indicator and Diode

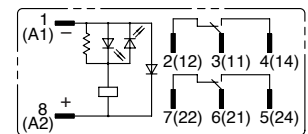
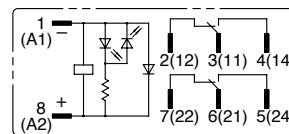

Coil voltage 24V DC and below

Coil voltage greater than 24V DC

Dimensions (mm)

Blade Relay (mm)

RJ1S

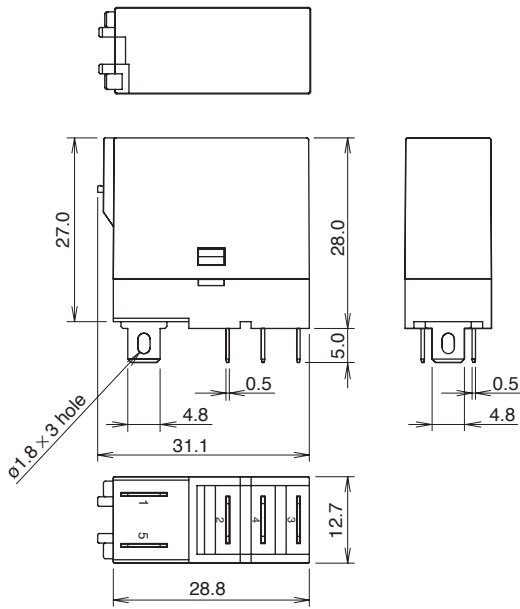

RJ2S

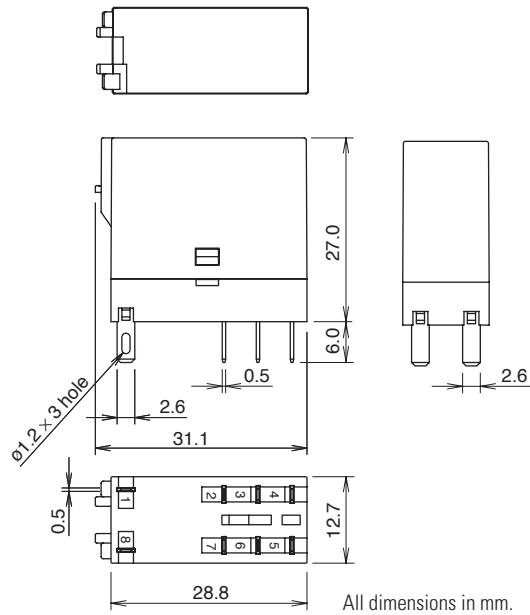

PCB Relay (mm)

RJ1V-C-*

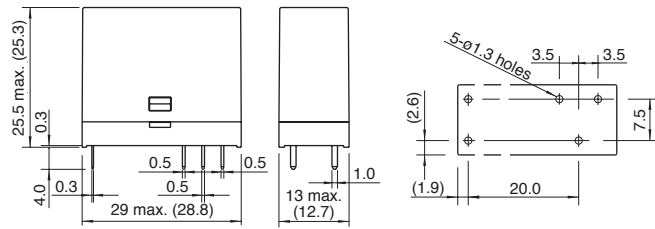

RJ1V-A-*

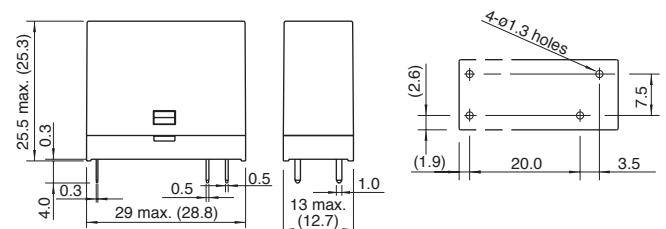

RJ1V-CH-*/RJ2V-C-*

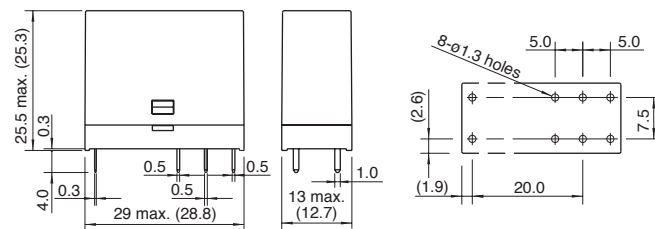

RJ1V-AH-*/RJ2V-A-*

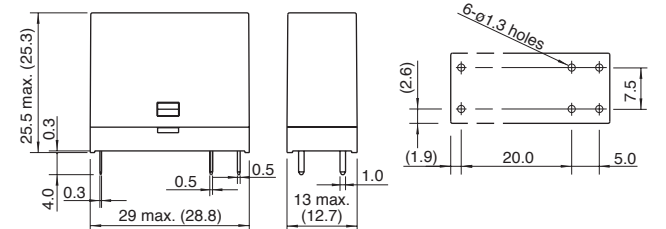

Dimensions con't (mm)

Standard DIN Rail Mount Sockets

SJ1S-05B

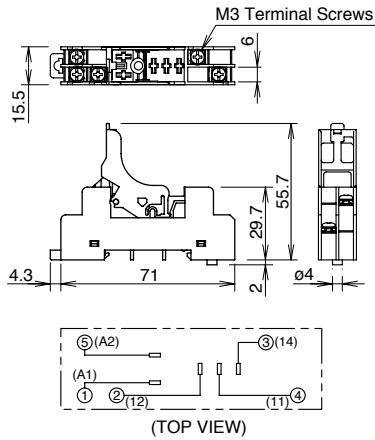

SJ2S-05B

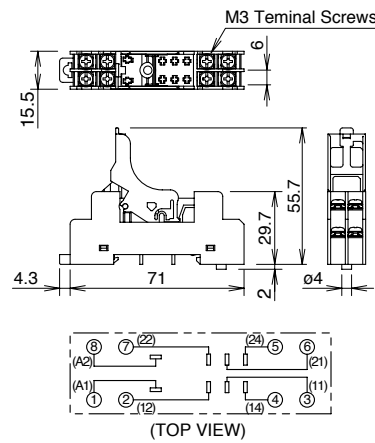

Finger-safe DIN Rail Mount Sockets

SJ1S-07L

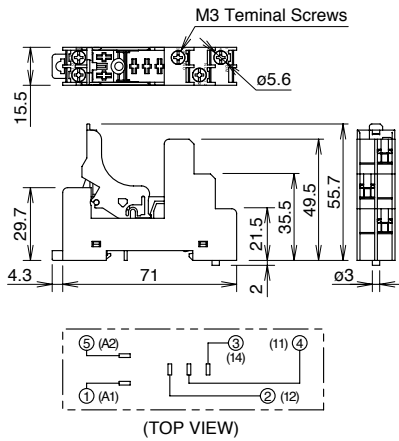

SJ2S-07L

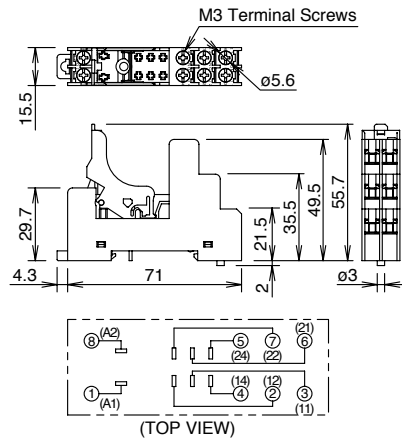

SQ1V-07B

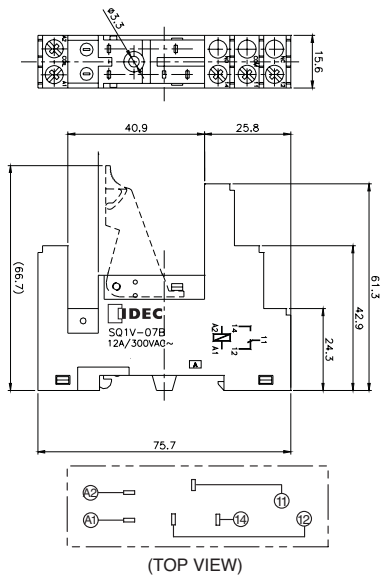

SQ2V-07B

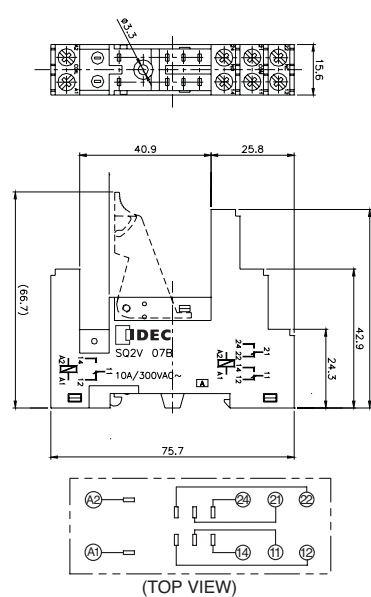

Switches & Pilot Lights

Display Lights

Relays & Sockets

Timers

Terminal Blocks

Circuit Breakers

Dimensions con't (mm)

PC Mount Sockets

SJ1S-61

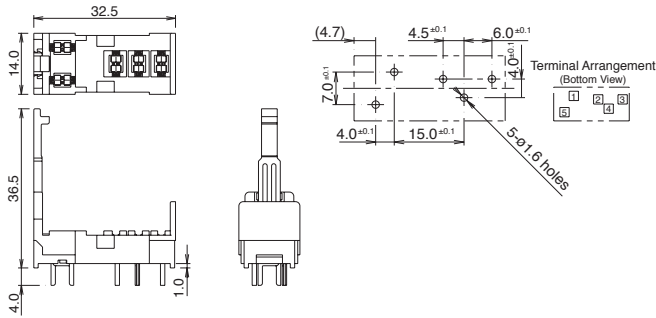

SJ2S-61

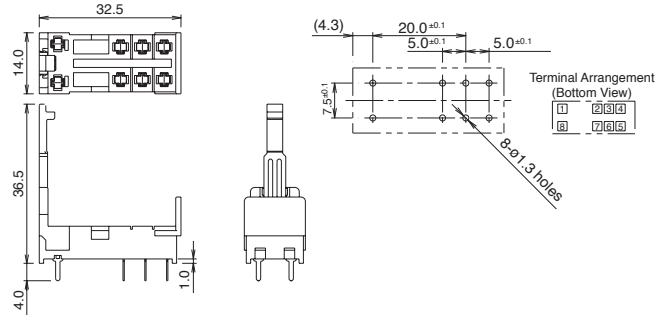

SQ1V-63

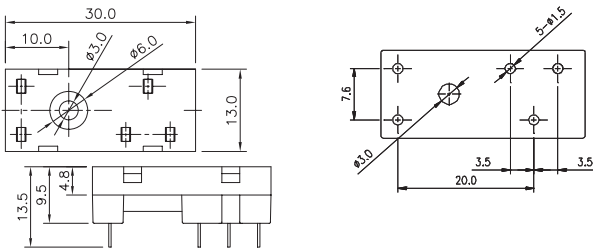

SQ2V-63

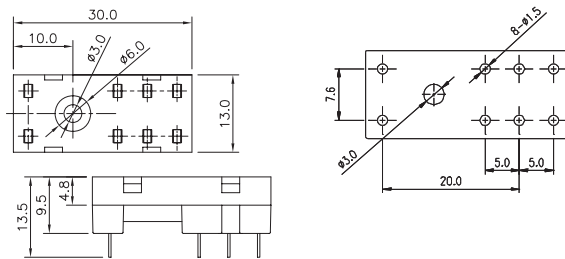

Switches & Pilot Lights

Display Lights

Relays & Sockets

Timers

Terminal Blocks

Circuit Breakers

RQ Series PCB Relays

IDEC RQ relays are low-profile, PCB relays that provide quality within a compact package. Size equals value. RQ relays are small, yet maintain high contact ratings and long operational life. For larger power needs, a 16A model is also available.



- Low profile:
29 x 12.7 x 15 mm
- Contact rating:
8A (DPDT) and 12A (SPDT)
- High capacity model with 16A (SPDT) contact rating
- Operational life:
100K cycles at full resistive load
10 million cycles, no load
- LED/Diode Plug-in modules available with DIN rail socket



UL Recognized
File No. E59804, Vol 1



Part Number Selection

		Part Number	
Contact	Model	Pin Terminal	Coil Voltage Code
 SPDT 12A	Basic	RQ1V-CM-□	A24, A115, A230, D12, D24
 SPDT 16A	High Capacity (HC)	RQ1V-CH-□	A24, A115, A230, D12, D24, D110
 DPDT 8A	Basic	RQ2V-CN-□	A24, A115, A230, D12, D24, D110

Ordering Information

When ordering, specify the Part No. and coil voltage code:

(example) **RQ1V-CM** **A115**
 Part No. Coil Voltage Code

Coil Voltage Table

Coil Voltage Code	A24	A115	A230	D12	D24	D110
Coil Rating	24V AC	110-120V AC	220-240V AC	12V DC	24V DC	110V DC

Switches & Pilot Lights

Display Lights

Relays & Sockets

Timers

Terminal Blocks

Circuit Breakers

Sockets

Relays	Finger-safe DIN Rail Mount	PCB Mount
RQ1	SQ1V-07B [†]	SQ1V-63*
RQ2 RQ1 HC	SQ2V-07B [†]	SQ2V-63*



- 1. *Comes with hold down spring
- 2. [†]Comes with retaining clip and marking plate.

Replacement Parts & Accessories

Part Number	Description	Part Number	Description
SQ9Z-C	Replacement retaining clip	SQ9Z-LD	Diode plug in modules for DIN socket
SQ9Z-C63	Replacement hold-down spring for SQ PCB sockets	SQ9Z-LR	RC plug-in module (110-230V AC) for DIN socket
SQ9Z-J8	8 pt jumper for DIN socket	SQ9Z-P	Replacement marking plate

Accessories

Description	Appearance	Use with	Part No.	Remarks
Aluminum DIN Rail (1 meter length)		All DIN rail sockets	BNDN1000	IDEC offers a low-profile DIN rail (BNDN1000). The BNDN1000 is designed to accommodate DIN mount sockets. Made of durable extruded aluminum, the BNDN1000 measures 0.413 (10.5mm) in height and 1.37 (35mm) in width (DIN standard). Standard length is 39" (1,000mm).
DIN Rail End Stop		DIN rail	BNL5	9.1 mm wide.

Specifications

Model (Contact)		RQ1	RQ1 HC	RQ2
No. of poles		1	1	2
Contact Configuration		SPDT	SPDT	DPDT
Contact Rating		12A	16A	8A
Contact Material		Silver-Nickel alloy		
Contact Resistance		100mΩ max		
Operating Time		12 ms		
Release Time		8 ms		
Dielectric Strength	Between contact & coil	5,000VAC, 1 minute		
	Between contacts	1,000VAC, 1 minute		
Vibration Resistance	Damage limits	10-55 Hz, amplitude 1.5mm		
	Operating extremes	10-55 Hz, amplitude 1.5mm		
Shock Resistance	Damage limits	100m/s ² min (10G)		
	Operating extremes	1,000m/s ² min (100G)		
Mechanical Life		10,000,000 operations		
Electrical Life @ Full Rated Load		100,000 operations		
Operating Temperature		-40 to 85° C		
Operating Humidity		45 to 85% RH		
Dimensions (H x W x D mm)		29 x 12.7 x 15		
Weight (Approx.)		15g		

Switches & Pilot Lights

Display Lights

Relays & Sockets

Timers

Terminal Blocks

Circuit Breakers

Coil Ratings

Rated Voltage	Nominal Current		Coil Resistance	Power Consumption		Pickup Voltage	Dropout Voltage	Max Allowable Voltage	
	50HZ	60HZ		50HZ	60HZ				
DC	12V	33.3mA	360Ω	0.40W		80% Max	5% Min	130%	
	24V	16.7mA	1,440Ω						
	110V	4.1mA	26,530Ω						
AC	24V	29.75mA	25.35mA	350Ω	0.71W	0.61W	80% Max	30% Min	130%
	115V	7.65mA	6.3mA	8,100Ω	0.88W	0.73W			
	230V	3.42mA	2.72mA	32,500Ω	0.79W	0.63W			

Socket Specifications

	Relays	Terminal	Electrical Rating	Wire Size	Torque
DIN Rail Sockets	SQ1V-07B	M3 screw with box clamp	300V, 12A	Maximum up to 2 - #14 AWG	1.0N•m Maximum
	SQ2V-07B	M3 screw with box clamp	300V, 8A	Maximum up to 2 - #14 AWG	1.0N•m Maximum
PCB Mount Socket	SQ1V-63	PCB mount	300V, 12A	—	—
	SQ2V-63	PCB mount	300V, 12A	—	—

Electrical Life Curves

RQ1 & RQ1 High Capacity

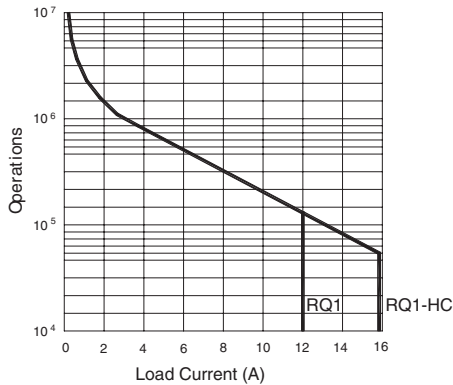

RQ2

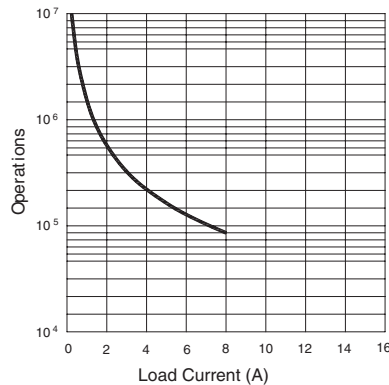

Maximum Switching Capacity

RQ1, RQ1 High Capacity & RQ2

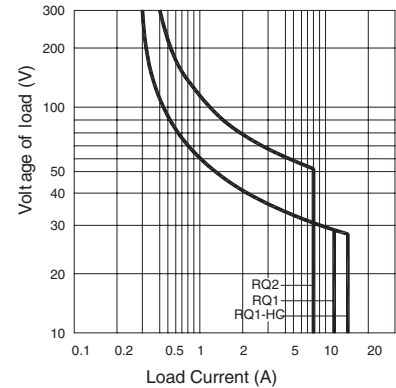

Internal Connection (View from Bottom)

RQ1

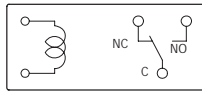

RQ2

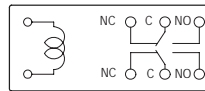

RQ1 HC

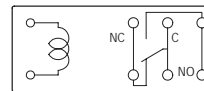

Dimensions (mm)

RQ1

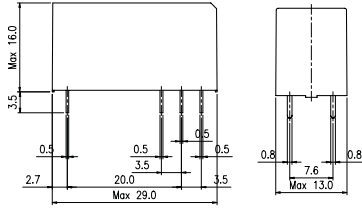

RQ2/RQ1 HC

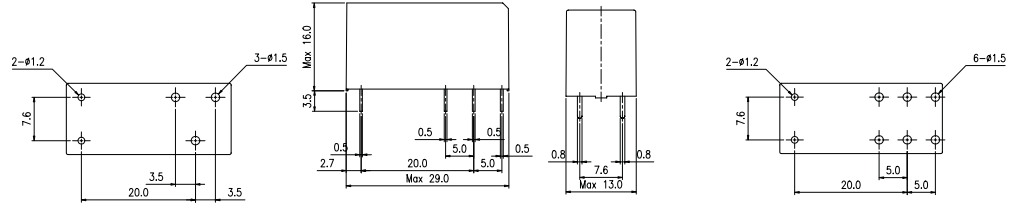

SQ Socket Dimensions

SQ1V-07B

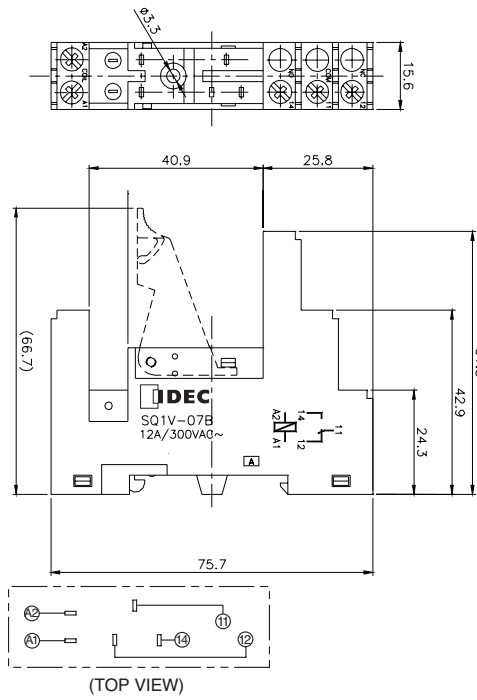

SQ2V-07B

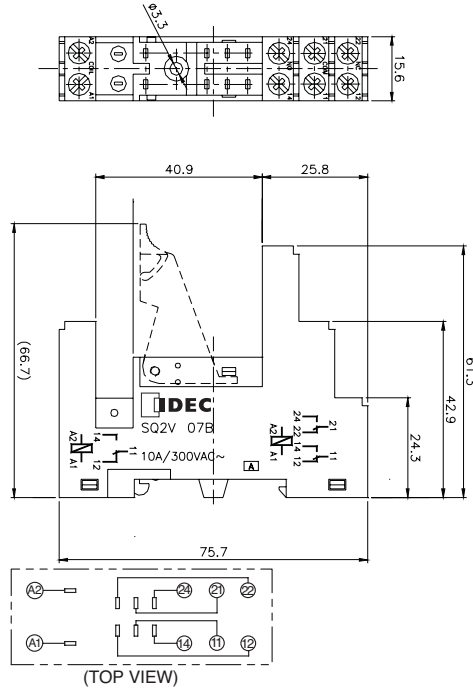

SQ1V-63 PCB Pin Layout

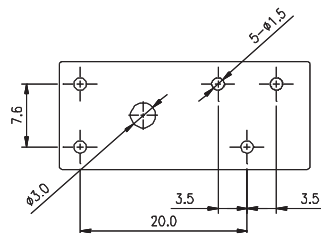

SQ1V-63

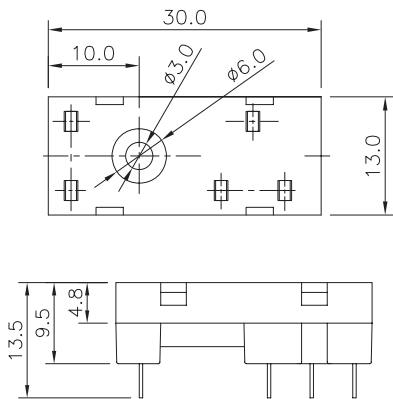

SQ2V-63 PCB Pin Layout

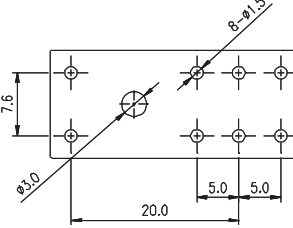

SQ2V-63

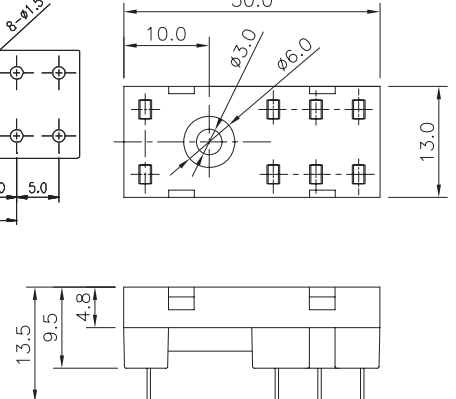

Switches & Pilot Lights

Display Lights

Relays & Sockets

Timers

Terminal Blocks

Circuit Breakers



RR Series Power Relays

**SPDT through 4PDT, 10A contacts
Midget power type relays**

- Available in pin and blade terminal styles.
- Options include an indicator, check button for test operations and side flange.
- DIN rail, surface and panel mount sockets are available for a wide a variety of mounting applications.



Part Number Selection

Contact	Model	Part Number		Coil Voltage Code (Standard Stock Items in Bold)
		Pin Terminal	Blade Terminal*	
 SPDT	Basic		RR1BA-U	AC6V, AC12V, AC24V, AC110V, AC120V , AC220V, AC240V, DC6V, DC12V, DC24V , DC48V, DC110V
	With Indicator		RR1BA-UL	
	With Check Button	—	RR1BA-UC	
	With Indicator and Check Button		RR1BA-ULC	
	Side Flange Model		RR1BA-US	
 DPDT	Basic	RR2P-U	RR2BA-U	
	With Indicator	RR2P-UL	RR2BA-UL	
	With Check Button	RR2P-UC	RR2BA-UC	
	With Indicator and Check Button	RR2P-ULC	RR2BA-ULC	
	Side Flange Model	—	RR2BA-US	
 3PDT	Basic	RR3PA-U	RR3B-U	
	With Indicator	RR3PA-UL	RR3B-UL	
	With Check Button	RR3PA-UC	RR3B-UC	
	With Indicator and Check Button	RR3PA-ULC	RR3B-ULC	
	Side Flange Model	—	RR3B-US	

 *Blade type not TUV tested or CE marked.

Ordering Information

When ordering, specify the Part No. and coil voltage code:

(example) **RR3B-U** **AC120V**
 Part No. Coil Voltage Code

Sockets

Relays	Standard DIN Rail Mount	Finger-safe DIN Rail Mount	Through Panel Mount
RR2P	SR2P-05 SR2P-06	SR2P-05C	SR2P-51
RR3PA	SR3P-05 SR3P-06	SR3P-05C	SR3P-51
RR1BA RR2BA RR3B	SR3B-05	—	SR3B-51



 All DIN rail mount sockets shown above can be mounted using DIN rail BNDN1000.

Hold Down Springs & Clips

Appearance	Description	Relay	For DIN Mount Socket	For Through Panel & PCB Mount Socket	Min Order Qty
	Pullover Wire Spring	RR2P	SR2B-02F1	SR3P-01F1	10 pcs
		RR3PA	SR3B-02F1		
		RR1BA, RR2BA, RR3B	SR3B-02F1	SR3B-02F1	
	Leaf Spring (side latch)	RR2P, RR3PA	SFA-203	—	20 pcs

Accessories

Description	Appearance	Use with	Part No.	Remarks
Aluminum DIN Rail (1 meter length)		All DIN rail sockets	BNDN1000	IDEC offers a low-profile DIN rail (BNDN1000). The BNDN1000 is designed to accommodate DIN mount sockets. Made of durable extruded aluminum, the BNDN1000 measures 0.413 (10.5mm) in height and 1.37 (35mm) in width (DIN standard). Standard length is 39" (1,000mm).
DIN Rail End Stop		DIN rail	BNL5	9.1 mm wide.
Replacement Hold-Down Spring Anchor		Horseshoe clip for sockets SR3B-05, SR2P-06, SR3P-06	Y778-011	For use on DIN rail mount socket when using pullover wire hold down spring. 2 pieces included with each socket.
		Chair clip for sockets SR2P-05(C), SR3P-05(C)	Y703-102	

Specifications

Contact Material	Silver		
Contact Resistance ¹	30 mΩ maximum		
Minimum Applicable Load	1V DC, 10 mA		
Operate Time ²	25 ms maximum		
Release Time ²	25 ms maximum		
Power Consumption (approx.)	AC: 3 VA (50 Hz), 2.5 VA (60 Hz) DC: 1.5W		
Insulation Resistance	100 MΩ minimum (500V DC megger)		
Dielectric Strength	Pin Terminal	Between live and dead parts:	1500V AC, 1 minute
		Between contact and coil:	1500V AC, 1 minute
		Between contacts of different poles:	1500V AC, 1 minute
		Between contacts of the same pole:	1000V AC, 1 minute
	Blade Terminal	Between live and dead parts:	2000V AC, 1 minute
		Between contact and coil:	2000V AC, 1 minute
		Between contacts of different poles:	2000V AC, 1 minute
		Between contacts of the same pole:	1000V AC, 1 minute
Operating Frequency	Electrical:	1800 operations/h maximum	
	Mechanical:	18,000 operations/h maximum	
Vibration Resistance	Damage limits:	10 to 55 Hz, amplitude 0.5 mm	
	Operating extremes:	10 to 55 Hz, amplitude 0.5 mm	
Shock Resistance	Damage limits:	1000 m/s ² (100g)	
	Operating extremes:	100 m/s ² (10G)	
Mechanical Life	10,000,000 operations		
Electrical Life	200,000 operations (220V AC, 5A)		
Operating Temperature ³	-25 to +40°C (no freezing)		
Operating Humidity	5 to 85% RH (no condensation)		
Weight (approx.) (Basic type)	RR2P: 90g, RR3PA: 96g, RR1BA/RR2BA/RR3B: 82g		



1. Measured using 5V DC, 1A voltage drop method
2. Measured at the rated voltage (at 20°C), excluding contact bouncing
3. For use under different temperature conditions, refer to Continuous Load Current vs. Operating Temperature Curve.

Coil Ratings

Switches & Pilot Lights

Display Lights

Rated Voltage (V)		Rated Current (mA) ±15% (at 20°C)		Coil Resistance (Ω) ±10% (at 20°C)	Operating Characteristics (values at 20°C)		
		50 Hz	60 Hz		Maximum Continuous Applied Voltage	Pickup Voltage	Dropout Voltage
AC (50/60 Hz)	6	490	420	4.9	110%	80% maximum	30% minimum
	12	245	210	18			
	24	121	105	79			
	110	27	23	1,680			
	120	24	20.5	2,100			
	240	12.1	10.5	8,330			
DC	6	240		25	110%	80% maximum	10% minimum
	12	120		100			
	24	60		400			
	48	30		1,600			
	110	13		8,460			

Contact Ratings

Relays & Sockets

Maximum Contact Capacity					
Continuous Current	Allowable Contact Power		Rated Load		
	Resistive Load	Inductive Load	Voltage (V)	Res. Load	Ind. Load
10A	1650VA AC 300W DC	1100VA AC 150W DC	110 AC	10A	7.5A
			220 AC	7.5A	5A
			30 DC	10A	5A

 Note: Inductive load for the rated load — $\cos \phi = 0.3$, $L/R = 7$ ms

TÜV Ratings

Timers

Voltage	
240V AC	10A
30V DC	10A

 AC: $\cos \phi = 1.0$, DC: $L/R = 0$ ms

UL Ratings

Voltage	Resistive	General use	Horse Power Rating
240V AC	10A	7A	1/3 HP
120V AC	10A	7.5A	1/4 HP
30V DC	10A	7A	—

CSA Ratings

Voltage	Resistive	General use
240V AC	10A	7A
120V AC	10A	7.5A
100V DC	—	0.5A
30V DC	10A	7.5A

Socket Specifications

Terminal Blocks

Circuit Breakers

	Relays	Terminal	Electrical Rating	Wire Size	Torque
DIN Rail Sockets	SR2P-05	M3 screw with captive wire clamp	300V, 10A	2-12 AWG	9 - 11.5in•lbs
	SR2P-05C	M3 screw with captive wire clamp, fingersafe	300V, 10A	2-12 AWG	9 - 11.5in•lbs
	SR2P-06	M3 screw with captive wire clamp	300V, 10A	2-12 AWG	9 - 11.5in•lbs
	SR3P-05	M3 screw with captive wire clamp	300V, 10A	2-12 AWG	9 - 11.5in•lbs
	SR3P-05C	M3 screw with captive wire clamp, fingersafe	300V, 10A	2-12 AWG	9 - 11.5in•lbs
	SR3P-06	M3 screw with captive wire clamp	300V, 10A	2-12 AWG	9 - 11.5in•lbs
	SR3B-05	M3 screw with captive wire clamp	300V, 15A (10A)* (*CSA rating)	2-12 AWG	9 - 11.5in•lbs
Through Panel Mount Sockets	SR2P-51	Solder	300V, 10A	—	—
	SR3P-51	Solder	300V, 10A	—	—
	SR3B-51	Solder	300V, 10A	—	—

Characteristics (Reference Data)

Electrical Life Curves

AC Load

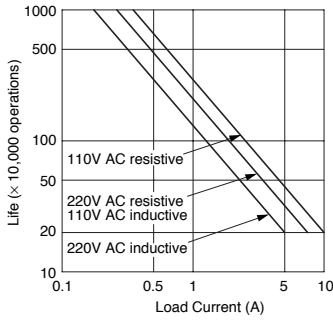

DC Load

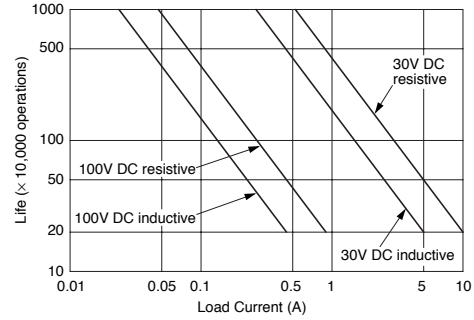

Maximum Switching Capacity

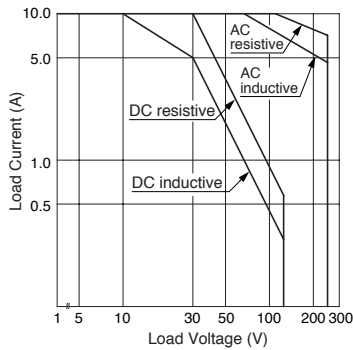

Continuous Load Current vs. Operating Temperature Curve (Basic Type, With Check Button, and Side Flange Type)

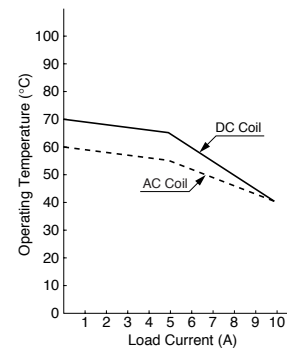

Internal Connection (View from Bottom)

Basic Type

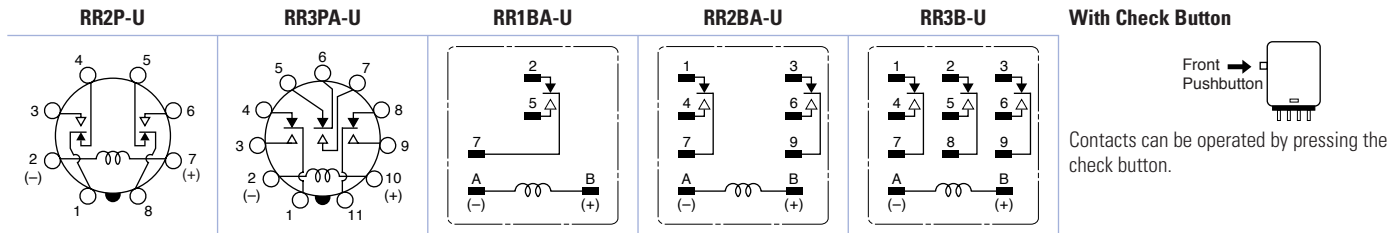

With Indicator (-UL type)

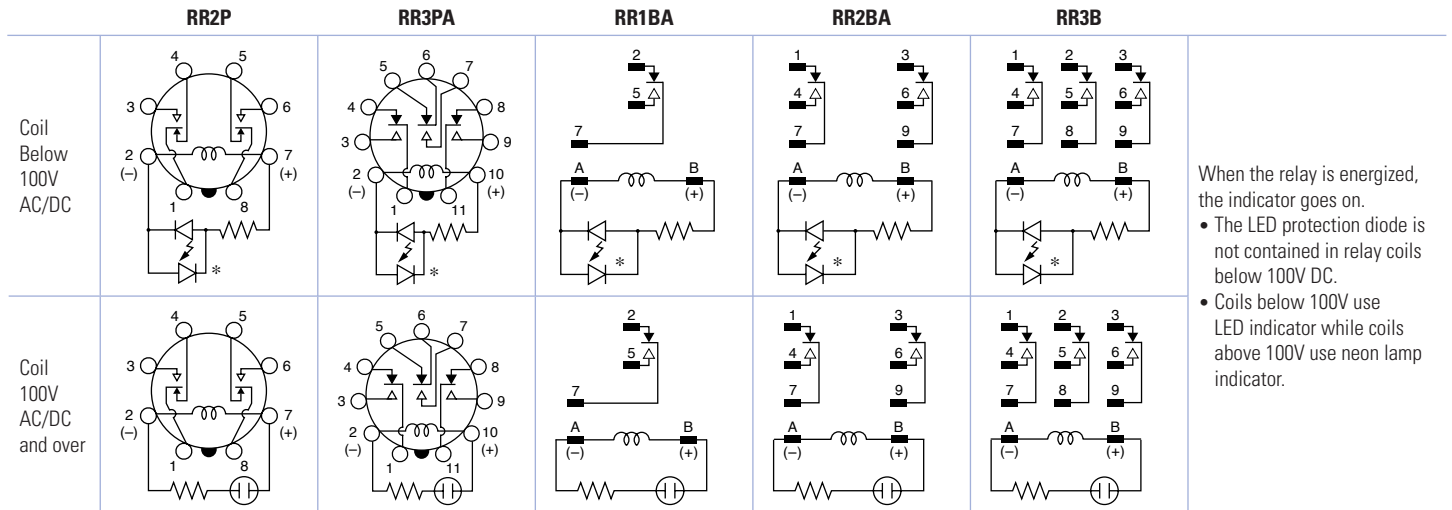

Dimensions (mm)

RR2P-U/RR2P-UL

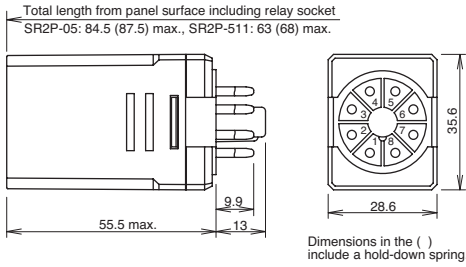

RR3PA-U/RR3PA-UL

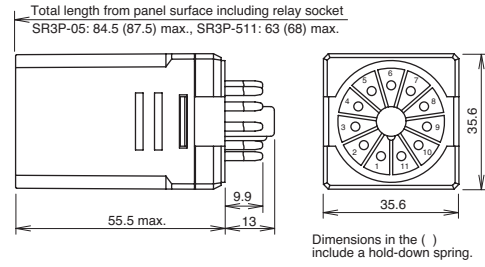

RR1BA-U/RR2BA-UL/RR2BA-U
RR2BA-UL/RR3B-U/RR3B-UL

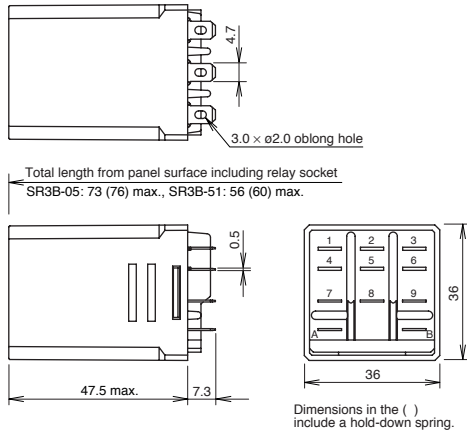

RR1BA-US/RR2BA-US/RR3B-US

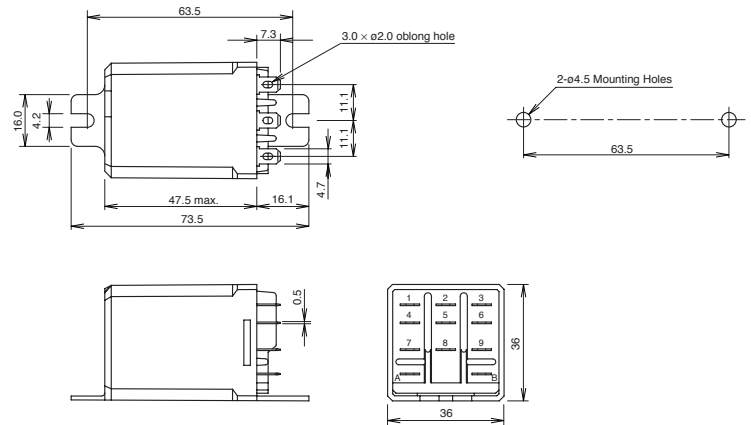

Standard DIN Rail Mount Sockets

SR2P-05

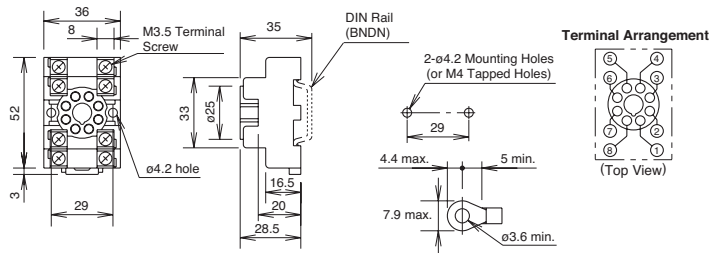

SR2P-06

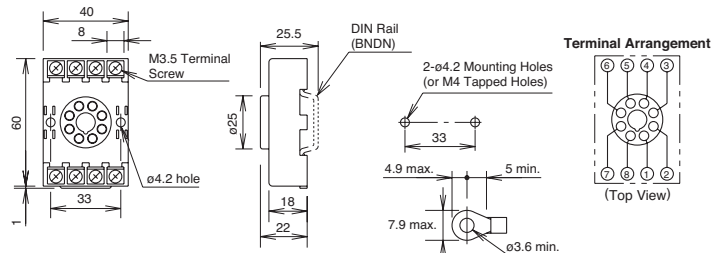

SR3P-05

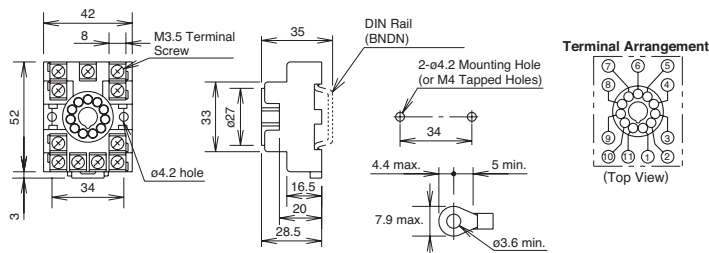

SR3P-06

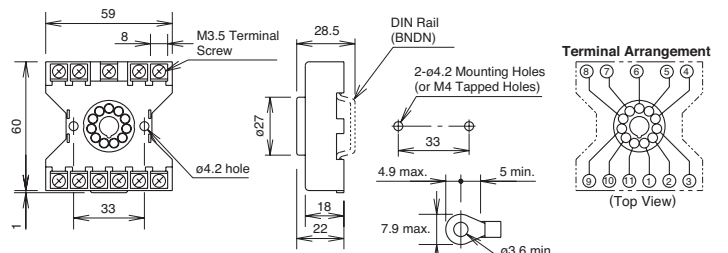

Switches & Pilot Lights

Display Lights

Relays & Sockets

Timers

Terminal Blocks

Circuit Breakers

Standard DIN Rail Mount Sockets

SR3B-05

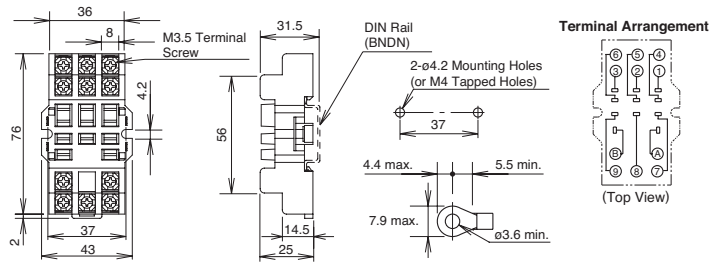

Finger-safe DIN Rail Mount Sockets

SR2P-05C

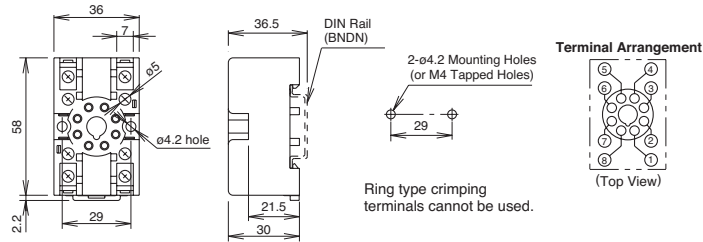

SR3P-05C

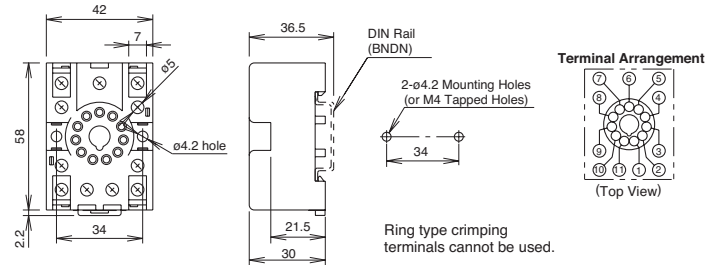

Through Panel Mount Socket

SR2P-51

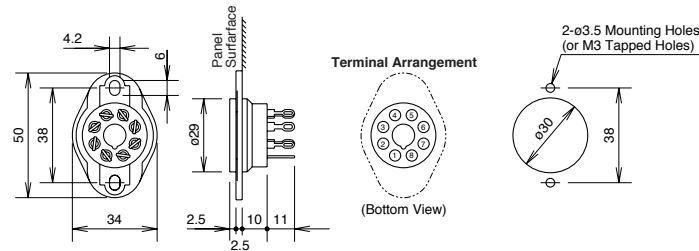

SR3P-51

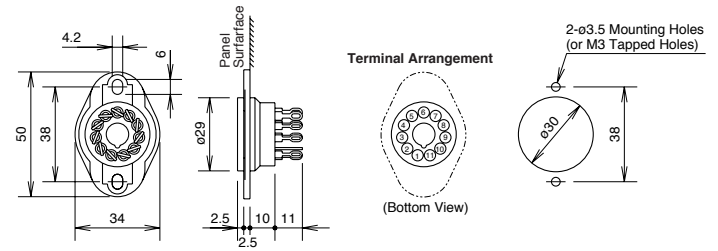

SR3B-51

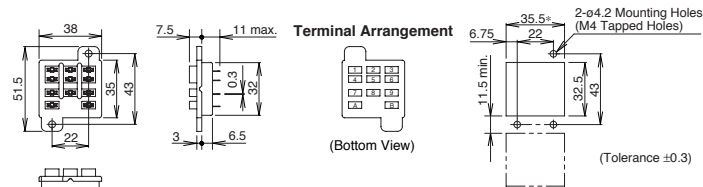

* When two or more sockets are mounted side by side:
 $L = 38(N - 1) + 35.5$
 N: No. of sockets mounted

RU Series Universal Relays

Full featured universal miniature relays Designed with environment taken into consideration

- Two terminal styles: plug-in and PCB mount
- Non-polarized LED indicator available on plug-in relays
- No internal wires, lead-free construction
- Cadmium-free contacts
- Mechanical flag indicator available on plug-in relays
- Manual latching lever with color coding for AC or DC coil
- Snap-on yellow marking plate; optional marking plates are available in four other colors
- Maximum contact ratings: 10A (RU2), 6A (RU4), 3A (RU42)
- UL Recognized, CSA Certified, EN Compliant



UL508
CSA C22.2 No. 14
File No. E66043



CSA C22.2 No. 14
CSA File No. LR35144



EN61810-1

With Latching or Momentary Lever

Mechanical Indicator*

The contact position can be confirmed through the five small windows.

Marking Plate

Standard yellow marking plate is easily replaced with optional marking plates in four colors for easy identification of relays.

LED Indicator*

Non-polarized green LED indicator is standard provision for plug-in terminal, latching lever types



Latching and Momentary Lever

Using the lever, operation can be checked without energizing the coil. The lever is color coded for AC and DC coils.

	Latching	Momentary
AC coil:	Orange	Red
DC coil:	Green	Blue

In Normal Operation



Note: Turn off the power to the relay coil when using the latching lever. After checking the operation, return the latching lever in the normal position.

Standard (without lever)

AC/DC Color Marking

For identification of AC or DC coils.

AC coil: Yellow
DC coil: Blue

Mechanical Indicator*

Marking Plate

LED Indicator*

Non-polarized green LED indicator is standard provision for plug-in terminal types.



AC Coil



DC Coil

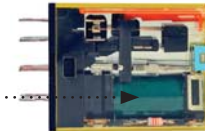

Coil Voltage	Tape Color
24V AC	White
100 to 110V AC	Clear
110 to 120V AC	Blue
200 to 220V AC	Black
220 to 240V AC	Red
24V DC	Green
6V DC	Voltage marking on yellow tape
12V DC	
48V DC	
110V DC	



*Not available on PCB type.

Part Number Selection

Contact	Model	Part Number			Coil Voltage Code (Standard Stock in bold)
		Standard	With Latching Lever	With Momentary Lever	
DPDT (10A) 	Standard	RU2S-C-	RU2S-	RU2S-M-	A24, A110, A220 D6, D12, D24 , D48, D110
	With RC (AC coil only)	RU2S-CR-	RU2S-R-	RU2S-MR-	A110, A220
	With diode (DC coil only)	RU2S-CD-	RU2S-D-	RU2S-MD-	D6, D12, D24 , D48, D110
	PCB	RU2V-NF-	—	—	A24, A110, A220 D6, D12, D24 , D48, D110
4PDT (6A) 	Standard	RU4S-C-	RU4S-	RU4S-M-	A24, A110, A220 D6, D12, D24 , D48, D110
	With RC (AC coil only)	RU4S-CR-	RU4S-R-	RU4S-MR-	A110, A220
	With diode (DC coil only)	RU4S-CD-	RU4S-D-	RU4S-MD-	D6, D12, D24, D48, D110
	PCB	RU4V-NF-	—	—	A24, A110 , A220 D6, D12, D24 , D48, D110
4PDT Bifurcated (3A) 	Standard	RU42S-C-	RU42S-	RU42S-M-	A24, A110, A220 D6, D12, D24 , D48, D110
	With RC (AC coil only)	RU42S-CR-	RU42S-R-	RU42S-MR-	A110, A220
	With diode (DC coil only)	RU42S-CD-	RU42S-D-	RU42S-MD-	D6, D12, D24, D48, D110
	PCB	RU42V-NF-	—	—	A24, A110, A220 D6, D12, D24 , D48, D110

- 1. Plug-in terminal models have an LED indicator and a mechanical indicator as standard.
- 2. PCB models do not have an LED indicator or a mechanical indicator.

Ordering Information

When ordering, specify the Part No. and coil voltage code:

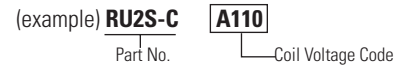

Coil Voltage Table

Coil Voltage Code	A24	A110	A220	D6	D12	D24	D48	D110
Coil Rating	24V AC	110-120V AC	220-240V AC	6V DC	12V DC	24V DC	48V DC	110V DC

Sockets

Relays	Spring Clamp DIN Rail Mount	Standard DIN Rail Mount	Finger-safe DIN Rail Mount	Panel Mount	PCB Mount
RU2S (DPDT)	SU2S-11L	SM2S-05	SM2S-05C	SY4S-51	SM2S-61 SM2S-62
RU4S (4PDT) RU42S (4PDT)	SU4S-11L	SY4S-05	SY4S-05C		SY4S-61 SY4S-62

Switches & Pilot Lights

Display Lights



Relays & Sockets

Timers

Terminal Blocks

Circuit Breakers

Hold Down Springs & Clips

Appearance	Description	Relay	For DIN Mount Socket	For Through Panel & PCB Mount Socket	Min Order Qty
	Pullover Wire Spring	RU2S/RU4S/ RU42S	SY4S-02F1	SY4S-51F1	10
	Leaf Spring (side latch)	RU2S/RU4S/ RU42S	SFA-202	SFA-302	20
	Leaf Spring (top latch)	RU2S/RU4S/ RU42S	SFA-101	SFA-301	

Accessories

Name	Part Number	Color Code *	Min. Order Qty.
Marking Plate	RU9Z-P*	A (orange), G (green), S (blue), W (white), Y (yellow)	10



Specify a color code when ordering. The marking plate can be removed from the relay by inserting a flat screwdriver under the marking plate.

Specifications

Model (Contact)	RU2 (DPDT)	RU4 (4PDT)	RU42 (4PDT)
Contact Material	Silver alloy	Silver (gold clad)	Silver-nickel (gold clad)
Contact Resistance ¹	50 mΩ maximum		
Minimum Applicable Load ²	24V DC, 5 mA (reference value)	1V DC, 1 mA	1V DC, 0.1 mA
Operate Time ³	20 ms maximum		
Release Time ³	20 ms maximum		
Power Consumption	AC: 1.1 to 1.4VA (50 Hz), 0.9 to 1.2VA (60 Hz) DC: 0.9 to 1.0W		
Insulation Resistance	100MΩ minimum (500V DC megger)		
Dielectric Strength	Between contact and coil: 2500V AC, 1 minute		
	Between contacts of different poles:		
	2500V AC, 1 minute	2000V AC, 1 minute	
Operating Frequency	Between contacts of the same pole: 1000V AC, 1 minute		
	Electrical: 1800 operations/h maximum Mechanical: 18,000 operations/h maximum		
Vibration Resistance	Damage limits: 10 to 55 Hz, amplitude 0.5 mm Operating extremes: 10 to 55 Hz, amplitude 0.5 mm		
Shock Resistance	Damage limits: 1000 m/s ² (100G) Operating extremes: 150 m/s ² (15G)		
Mechanical Life	AC: 50,000,000 operations DC: 100,000,000 operations		50,000,000 operations
Electrical Life ⁴	See table on page 758		
Operating Temperature ⁵	PCB model: -55 to +70°C (no freezing) Blade model: -55 to +60°C (no freezing)		
Operating Humidity	5 to 85% RH (no condensation)		
Weight	Approx. 35g		



1. Measured using 5V DC, 1A voltage drop method
2. Measured at operating frequency of 120 operations/min (failure rate level P, reference value)
3. Measured at the rated voltage (at 20°C), excluding contact bouncing;
Release time of AC relays with RC: 25 ms maximum
Release time of DC relays with diode: 40 ms maximum
4. Contact Load and Electrical Life (at ambient temperature 20°C)
5. Measured at the rated voltage.

Switches & Pilot Lights

Display Lights

Relays & Sockets

Timers

Terminal Blocks

Circuit Breakers

Accessories

Description	Appearance	Use with	Part No.	Remarks
Aluminum DIN Rail (1 meter length)		All DIN rail sockets	BNDN1000	IDEC offers a low-profile DIN rail (BNDN1000). The BNDN1000 is designed to accommodate DIN mount sockets. Made of durable extruded aluminum, the BNDN1000 measures 0.413 (10.5mm) in height and 1.37 (35mm) in width (DIN standard). Standard length is 39" (1,000mm).
DIN Rail End Stop		DIN rail	BNL5	9.1 mm wide.
Replacement Hold-Down Spring Anchor		Horseshoe clip for DIN rail sockets	Y778-011	For use on DIN rail mount socket when using pullover wire hold down spring. 2 pieces included with each socket.

Coil Ratings

Rated Voltage (V)		Coil Voltage Code	Rated Current (mA) ±15% (at 20°C)		Coil Resistance (Ω) ±10% (at 20°C)	Operating Characteristics (values at 20°C)		
			50 Hz	60 Hz		Maximum Continuous Applied Voltage	Pickup Voltage	Dropout Voltage
AC (50/60 Hz)	24	A24	49.3	42.5	164	110%	80% maximum	30% minimum
	110-120	A110	8.4-10.0	7.1-8.2	4,550			
	220-240	A220	4.2-5.0	3.6-4.2	18,230			
DC	6	D6	155		40	110%	80% maximum	10% minimum
	12	D12	80		160			
	24	D24	44.7		605			
	48	D48	18		2,560			
	110	D110	8.9		12,100			

1. The rated current includes the current of the LED indicator.

Surge Suppressor Ratings

Model		Ratings
AC Coil	With RC	RC series circuit R: 20 kΩ, C: 0.033 μF
DC Coil	With Diode	Diode reverse voltage: 1000V Diode forward current: 1A

UL and c-UL Ratings

Voltage	Resistive			General Use			Horse Power Rating		
	RU2	RU4	RU42	RU2	RU4	RU42	RU2	RU4	RU42
250V AC	10A	—	3A	—	6A	—	—	1/10HP	—
30V DC	10A	6A	3A	—	—	—	—	—	—

Contact Ratings

Maximum Contact Capacity						
Contact	Continuous Current	Allowable Contact Power		Voltage (V)	Rated Load	
		Resistive Load	Inductive Load		Res. Load	Ind. Load
DPDT	10A	250VA AC	1250VA AC	250 AC	10A	5A
		300W DC	150W DC	30 DC	10A	5A
4PDT	6A	1500VA AC	600VA AC	250 AC	3A	0.8A
		180W DC	90W DC	30 DC	3A	1.5A
4PDT bifurcated	3A	750VA AC	200VA AC	250 AC	3A	0.8A
		90W DC	45W DC	30 DC	3A	1.5A

1. On 4PDT relays, the maximum allowable total current of neighboring two poles is 6A. At the rated load, make sure that the total current of neighboring two poles does not exceed 6A (3A + 3A = 6A).
2. Inductive load for the rated load — cos φ = 0.3, L/R = 7 ms

CSA Ratings

Voltage	Resistive
	RU42
250V AC	3A
30V DC	3A

TÜV Ratings

Voltage	Resistive			Inductive		
	RU2	RU4	RU42	RU2	RU4	RU42
250V AC	10A	6A	3A	5A	0.8A	0.8A
30V DC	10A	6A	3A	5A	1.5A	1.5A

Socket Specifications

	Sockets	Terminal	Electrical Rating	Wire Size	Torque
DIN Rail Mount Sockets	SU2S-11L	Spring clamp terminals	250V/10A	24-16 AWG	—
	SU4S-11L	Spring clamp terminals	250V/6A (using RU4), 10A (using RU2)	24-16 AWG	—
	SM2S-05	M3 screw with captive wire clamp	300V, 10A	Maximum up to 2-#14AWG	5.5 - 9in•lbs
	SM2S-05C	M3 screw with captive wire clamp, fingersafe	300V, 10A	Maximum up to 2-#14AWG	5.5 - 9in•lbs
	SY4S-05	M3 screw with captive wire clamp	300V, 7A (using RU4), 10A (using RU2)	Maximum up to 2-#14AWG	5.5 - 9in•lbs
	SY4S-05C	M3 screw with captive wire clamp, fingersafe	300V, 7A (using RU4), 10A (using RU2)	Maximum up to 2-#14AWG	5.5 - 9in•lbs
Through Panel Mount Socket	SY4S-51	Solder	300V, 7A	—	—
PCB Mount Socket	SY4S-61	PCB mount	300V, 7A	—	—
	SY4S-62	PCB mount	250V, 7A	—	—

Electrical Life Curves

RU2 (Resistive Load)

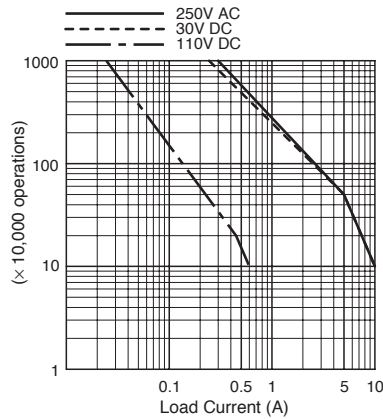

RU4 (Resistive Load)

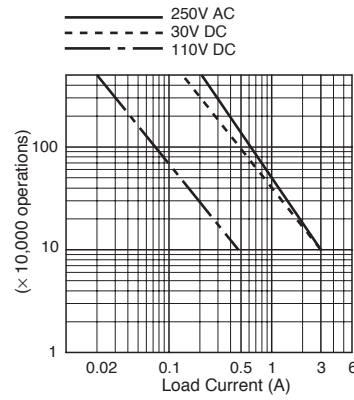

RU42 (Resistive Load)

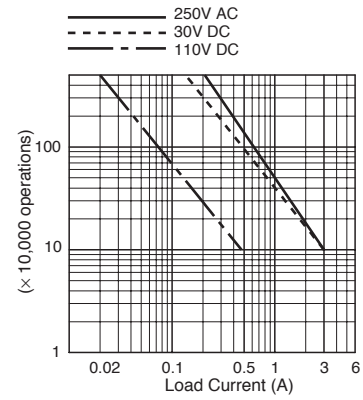

RU2 (Inductive Load)

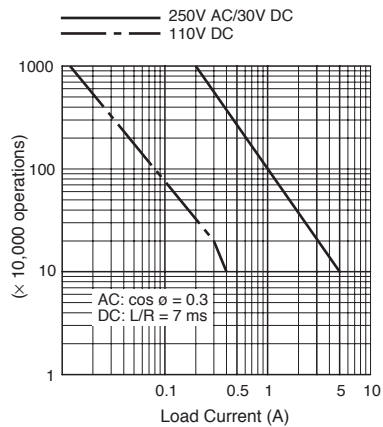

RU4 (Inductive Load)

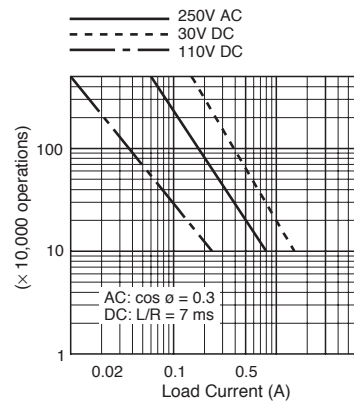

RU42 (Inductive Load)

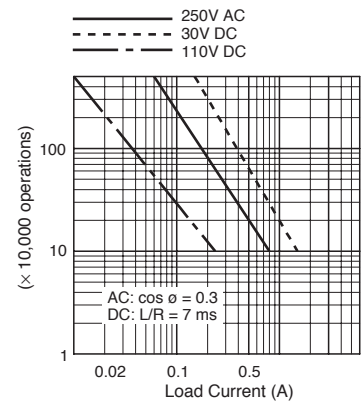

Maximum Switching Current

RU2

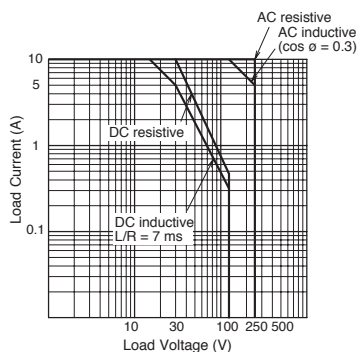

RU4

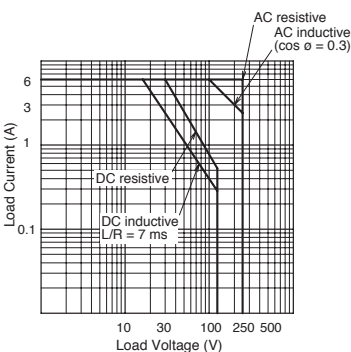

RU42 (Bifurcated)

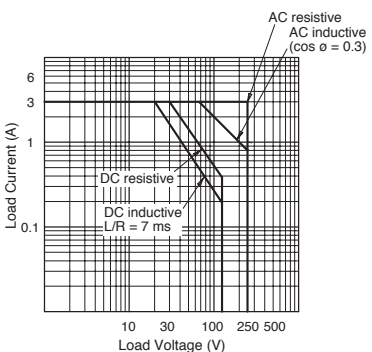

Ambient Temperature vs. Temperature Rise Curves

RU2 (AC Coil, 50 Hz)

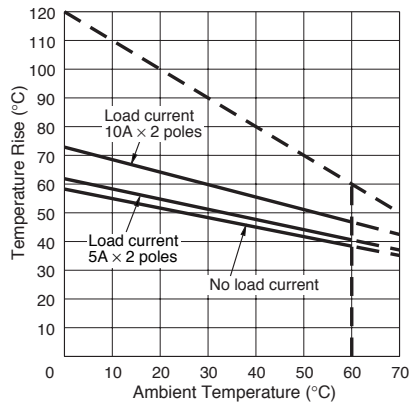

RU2 (AC Coil, 60 Hz)

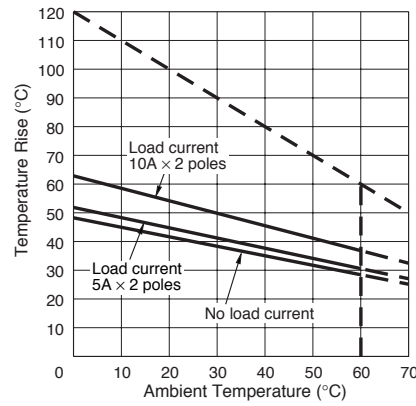

RU2 (DC Coil)

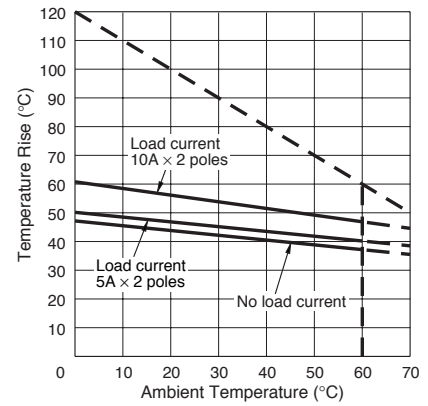

RU4/RU42 (AC Coil, 50 Hz)

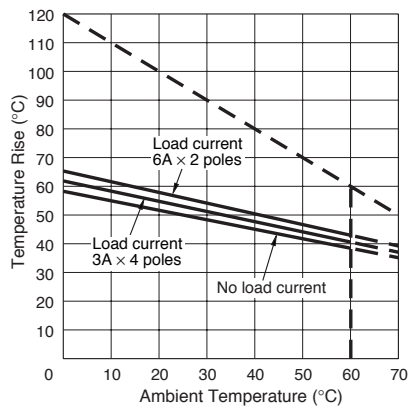

RU4/RU42 (AC Coil, 60 Hz)

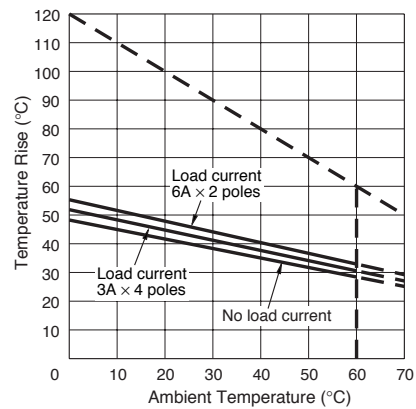

RU4/RU42 (DC Coil)

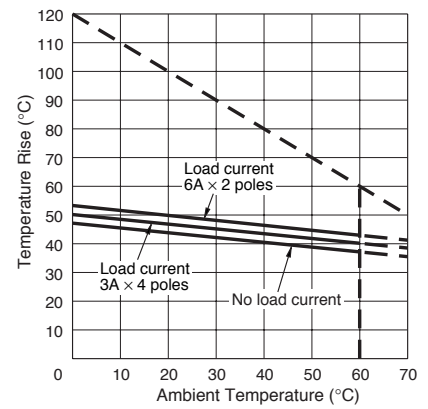

The above temperature rise curves show the characteristics when 100% the rated coil voltage is applied. The heat resistance of the coil is 120°C. The slant dashed line indicates the allowable temperature rise for the coil at different ambient temperatures. Load current 6A x 2 poles is for the RU4 models only.

Internal Connection (View from Bottom)

RU2S-* Standard

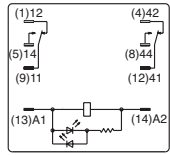

24V AC/DC coil or less

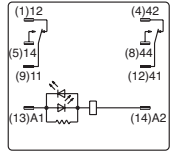

Over 24V AC/DC coil

RU2S-*R with RC

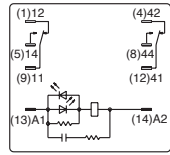

RU2S-*D With Diode

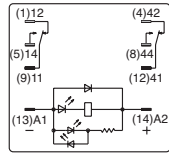

24V DC coil or less

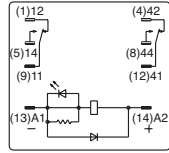

Over 24V DC coil

RU2V-NF-*

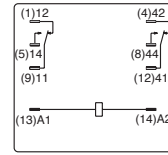

RU4S-*/RU42S-* Standard

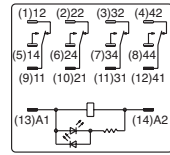

24V AC/DC coil or less

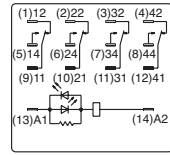

Over 24V AC/DC coil

RU4S-*R/RU42S-*R With RC

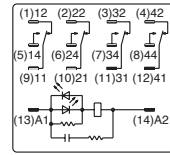

RU4S-*D/RU42S-*D With Diode

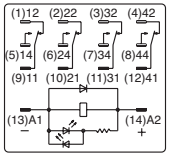

24V DC coil or less

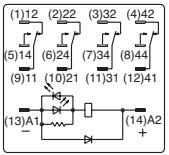

Over 24V DC coil

RU4V-NF-*/RU42V-NF-*

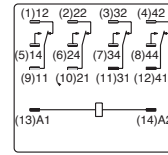

Dimensions (mm)

RU2S

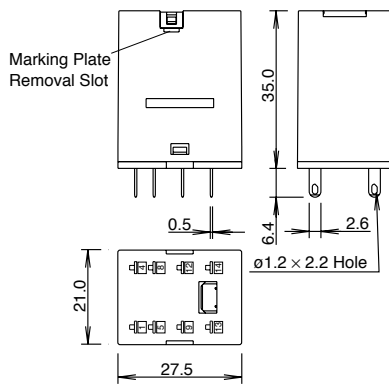

RU2V

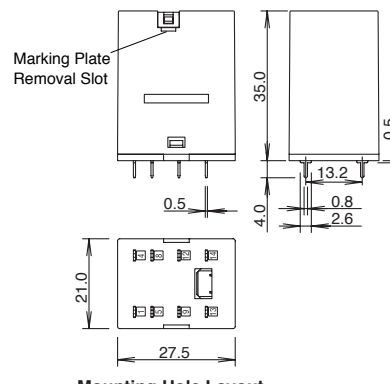

Marking plate removal slot is provided only on one side. Insert a flat screwdriver into the slot to remove the marking plate.

Mounting Hole Layout

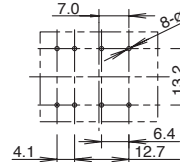

All dimensions in mm.

Dimensions con't (mm)

RU4S

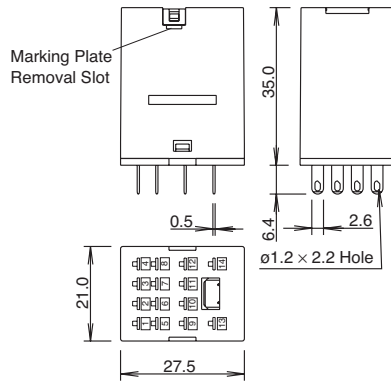

Marking plate removal slot is provided only on one side. Insert a flat screwdriver into the slot to remove the marking plate.

RU4V, RU42V

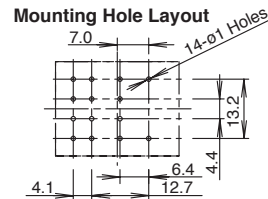
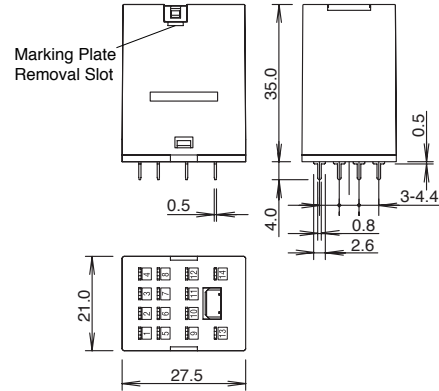

All dimensions in mm.

Spring Clamp DIN Rail Mount Sockets

SU2S-11L

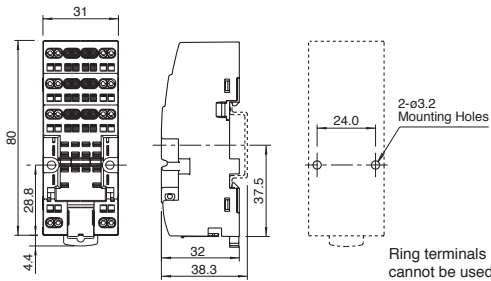

Terminal Arrangement

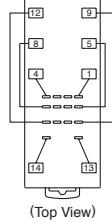

SU4S-11L

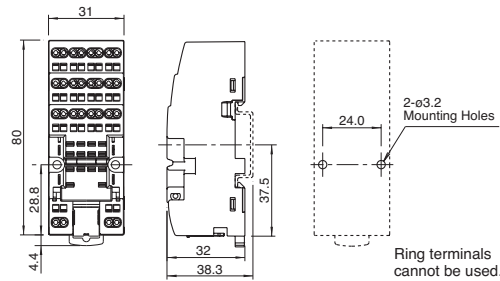

Terminal Arrangement

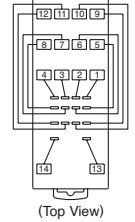

Standard DIN Rail Mount Sockets

SM2S-05

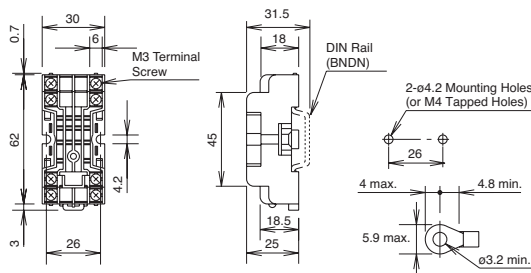

Terminal Arrangement

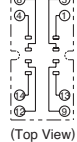

SY4S-05

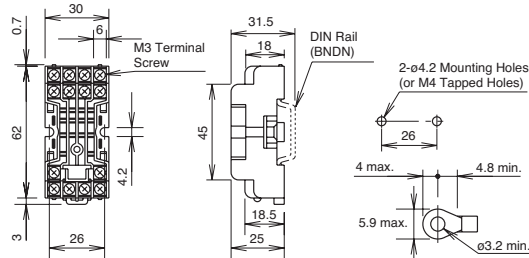

Terminal Arrangement

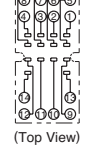

Dimensions con't (mm)

Finger-safe DIN Rail Mount Sockets

SM2S-05C

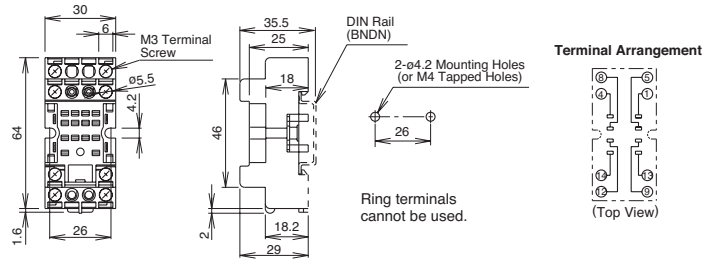

SY4S-05C

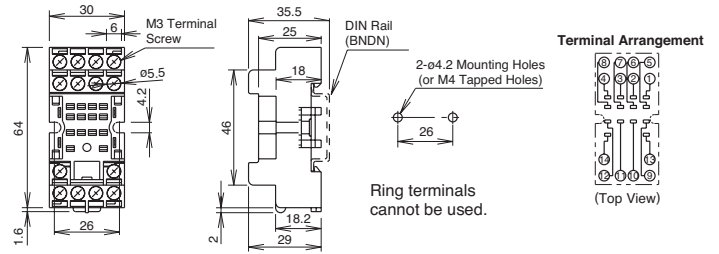

PCB Mount Sockets

SM2S-61

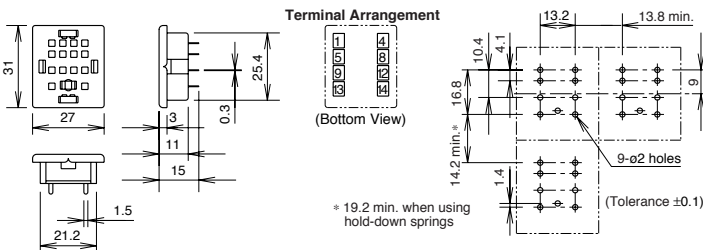

SM2S-62

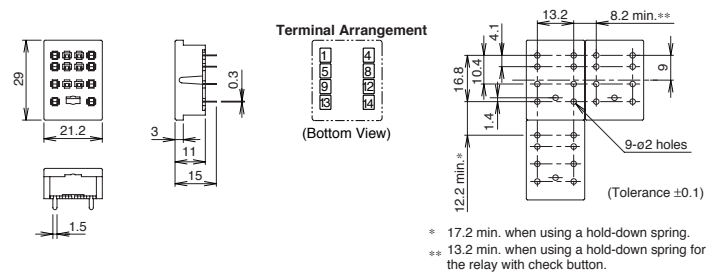

SY4S-61

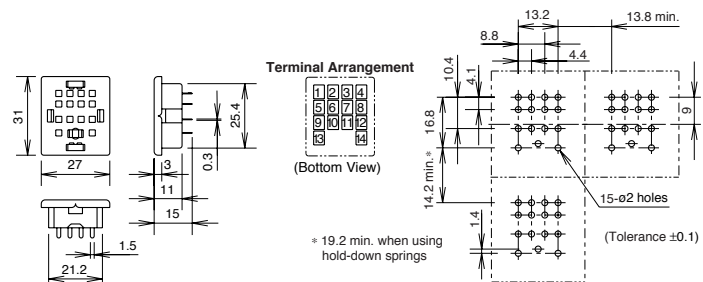

SY4S-62

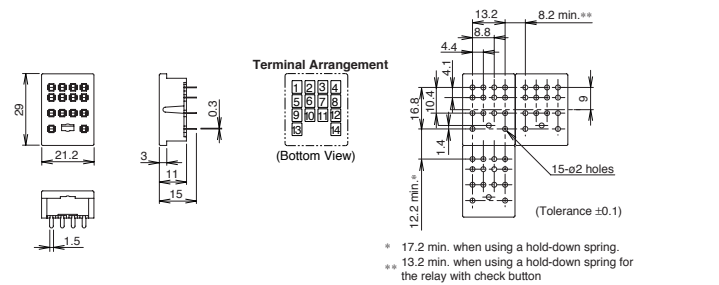

Through Panel Mount Socket

SY4S-51

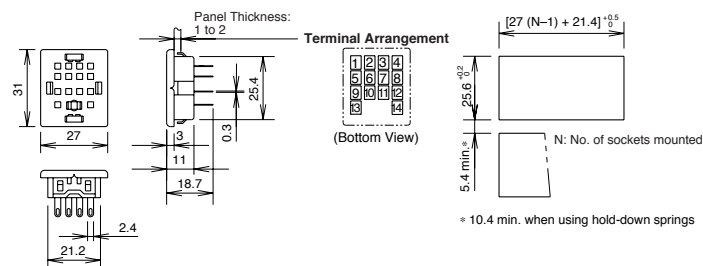

Switches & Pilot Lights

Display Lights

Relays & Sockets

Timers

Terminal Blocks

Circuit Breakers

RY/RM Series Miniature Relays

RY2 (3A), RY4 (5A), RM2 (5A)
Bifurcated contacts are also available

The RY/RM series are general purpose miniature relays with a 3A or 5A contact capacity. A wide variety of terminal styles and coil voltages meet a wide range of applications. All 4PDT types have arc barriers.



Part Number Selection

Contact	Model	Part Number		Coil Voltage Code
		Plug-in Terminal	PC Board Terminal	
DPDT (Slim) 3A 	Basic	RY2S-U	RY2V-U	AC6V, AC12V, AC24V, AC110V, AC120V, AC220V, AC240V DC6V, DC12V, D24V, DC48V, DC110V
	With Indicator	RY2S-UL	RY2V-UL	
	With Check Button	RY2S-UC		
	With Indicator and Check Button	RY2S-ULC		
	Top Bracket Mounting	RY2S-UT		
	With Diode (DC coil only)	RY2S-UD	RY2V-UD	
DPDT (Wide) 5A 	Basic	RM2S-U	RM2V-U	AC6V, AC12V, AC24V, AC110-120V, AC220-240V DC6V, DC12V, DC24V, DC48V, DC100-110V
	With Indicator	RM2S-UL	RM2V-UL	
	With Check Button	RM2S-UC		
	With Indicator and Check Button	RM2S-ULC		
	Top Bracket Mounting	RM2S-UT		
	With Diode (DC coil only)	RM2S-UD		
4PDT 5A 	Basic	RY4S-U	RY4V-U	AC6V, AC12V, AC24V, AC110-120V, AC220-240V DC6V, DC12V, DC24V, DC48V, DC100-110V
	With Indicator	RY4S-UL	RY4V-UL	
	With Check Button	RY4S-UC		
	With Indicator and Check Button	RY4S-ULC		
	Top Bracket Mounting	RY4S-UT		
	With Diode (DC coil only)	RY4S-UD	—	
DPDT (Slim) 1A Bifurcated 	Basic	RY22S-U	RY22V-U	AC6V, AC12V, AC24V, AC110V, AC120V, AC220V, AC240V DC6V, DC12V, D24V, DC48V, DC110V
	With Indicator	RY22S-UL	RY22V-UL	
	Top Bracket Mounting	RY22S-UT		
	With Diode (DC coil only)	RY22S-UD	RY22V-UD	
4PDT 1A Bifurcated 	Basic	RY42S-U	RY42V-U	AC6V, AC12V, AC24V, AC110-120V, AC220-240V DC6V, DC12V, DC24V, DC48V, DC100-110V
	With Indicator	RY42S-UL	RY42V-UL	
	Top Bracket Mounting	RY42S-UT		

Ordering Information

When ordering, specify the Part No. and coil voltage code:

(example) **RY4S-U** **AC110-120V**
 Part No. Coil Voltage Code

Sockets

Relays	Standard DIN Rail Mount	Finger-safe DIN Rail Mount	Through Panel Mount	PCB Mount
RY2S RY22S	SY2S-05	SY2S-05C	SY2S-51	SY2S-61
RM2	SM2S-05	SM2S-05C	SM2S-51	SY4S-61 SY4S-62
RY4S RY42S	SY4S-05	SY4S-05C	SY4S-51	

Hold Down Springs & Clips

Appearance	Description	Relay	For DIN Mount Socket	For Through Panel & PCB Mount Socket	Min Order Qty
	Pullover Wire Spring	RY2S	SY2S-02F1	SY4S-51F1	10
		RY22S			
		RM2	SY4S-51F1	SY4S-51F1	
		RY4S			
		RY42S			
	Leaf Spring* (side latch)	RY2S, RY22S	SFA-202	SFA-302	20
		RM2, RY4S, RY42S			
	Leaf Spring* (top latch)	RY2S, RY22S	SFA-101	SFA-301	
		RM2			
		RY4S, RY42S			

*Not available for PCB mount socket SY4S-62.

Accessories

Description	Appearance	Use with	Part No.	Remarks
Aluminum DIN Rail (1 meter length)		All DIN rail sockets	BNDN1000	IDEC offers a low-profile DIN rail (BNDN1000). The BNDN1000 is designed to accommodate DIN mount sockets. Made of durable extruded aluminum, the BNDN1000 measures 0.413 (10.5mm) in height and 1.37 (35mm) in width (DIN standard). Standard length is 39" (1,000mm).
DIN Rail End Stop		DIN rail	BNL5	9.1 mm wide.
Replacement Hold-Down Spring Anchor		Horseshoe clip for all DIN rail sockets	Y778-011	For use on DIN rail mount socket when using pullover wire hold down spring. 2 pieces included with each socket.

Specifications

Contact Model	Standard Contact			Bifurcated Contact
	RY2 - DPDT Slim	RM2 - DPDT Wide	RY4 - 4PDT	RY22 - DPDT / RY42 - 4PDT
Contact Material	Gold-plated silver	Silver	Gold-plated silver	Silver-palladium alloy
Contact Resistance ¹	50 mΩ maximum	30 mΩ maximum	50 mΩ maximum	100 mΩ minimum
Minimum Applicable Load	24V DC, 5 mA; 5V DC, 10 mA (reference value)	24V DC, 10 mA; 5V DC, 20 mA (reference value)	24V DC, 5 mA; 5V DC, 10 mA (reference value)	1V DC, 100 μA (reference value)
Operate Time ²	20 ms maximum			
Release Time ²	20 ms maximum			
Power Consumption (approx.)	AC: 1.1 VA (50 Hz), 1 VA (60 Hz) DC: 0.8W	AC: 1.4 VA (50 Hz), 1.2 VA (60 Hz) DC: 0.9W	AC: 1.4 VA (50 Hz), 1.2 VA (60 Hz) DC: 0.9W	AC: 1.1 VA (50 Hz), 1 VA (60 Hz) DC: 0.8W
Insulation Resistance	100 MΩ minimum (500V DC megger)			
Dielectric Strength ³	Between live and dead parts:			
	1500V AC, 1 minute	2000V AC, 1 minute	2000V AC, 1 minute	1500V AC, 1 minute ³
	Between contact and coil:			
	1500V AC, 1 minute	2000V AC, 1 minute	2000V AC, 1 minute	1500V AC, 1 minute
	Between contacts of different poles:			
	1500V AC, 1 minute	2000V AC, 1 minute	2000V AC, 1 minute	1500V AC, 1 minute
Operating Frequency	Electrical: 1800 operations/h maximum			
	Mechanical: 18,000 operations/h maximum			
Vibration Resistance	Damage limits: 10 to 55 Hz, amplitude 0.5 mm			
	Operating extremes: 10 to 55 Hz, amplitude 0.5 mm			
Shock Resistance	Damage limits: 1000 m/s ²			
	Operating extremes: 100 m/s ² (DPDT Slim), 200 m/s ² (4PDT, DPDT Wide)			
Mechanical Life	50,000,000 operations			
Electrical Life	200,000 operations (220V AC, 3A)	500,000 operations (220V AC, 5A)	100,000 operations (220V AC, 5A) 200,000 operations (220V AC, 3A)	200,000 operations (110V AC, 1A)
Operating Temperature ⁴	-25 to +55°C (no freezing)	-25 to +45°C (no freezing)	-25 to +55°C (no freezing) ⁵	-25 to +55°C (no freezing)
Operating Humidity	45 to 85% RH (no condensation)			
Weight (approx.)	23g	35g	34g	RY22: 23g / RY42: 34g



Note: Above values are initial values.

1. Measured using 5V DC, 1A voltage drop method
2. Measured at the rated voltage (at 20°C), excluding contact bouncing
Release time of relays with diode: 40 ms maximum

3. Relays with indicator or diode: 1000V AC, 1 minute

4. For use under different temperature conditions, refer to Continuous Load Current vs. Operating Temperature Curve.
The operating temperature range of relays with indicator or diode is -25 to +40°C.

5. When the total current of 4 contacts is less than 15A, the operating temperature range is -25 to +70°C.

AC Coil Ratings

Voltage (V)	Rated Current (mA) ±15% at 20°C				Coil Resistance (Ω) ±10% at 20°C		Operation Characteristics (against rated values at 20°C)		
	AC 50Hz		AC 60Hz		DPDT Slim	DPDT Wide & 4PDT	Max. Continuous Applied Voltage	Pickup Voltage	Dropout Voltage
	DPDT Slim	DPDT Wide & 4PDT	DPDT Slim	DPDT Wide & 4PDT					
6	170	240	150	200	18.8	9.4	110%	80% maximum	30% minimum
12	86	121	75	100	76.8	39.3			
24	42	60.5	37	50	300	153			
110	9.6	—	8.4	—	6,950	—			
110-120	—	9.4-10.8	—	8.0-9.2	—	4,290			
120	8.6	—	7.5	—	8,100	—			
220	4.7	—	4.1	—	25,892	—			
220-240	—	4.7-5.4	—	4.0-4.6	—	18,820			
240	4.9	—	4.3	—	26,710	—			

DC Coil Ratings

Voltage (V)	Rated Current (mA) ±15% at 20°C		Coil Resistance (Ω) ±10% at 20°C		Operation Characteristics (against rated values at 20°C)		
	DPDT Slim	DPDT Wide & 4PDT	DPDT Slim	DPDT Wide & 4PDT	Max. Continuous Applied Voltage	Pickup Voltage	Dropout Voltage
6	128	150	47	40	110%	80% maximum	10% minimum
12	64	75	188	160			
24	32	36.9	750	650			
48	18	18.5	2,660	2,600			
100-110	—	8.2-9.0	—	12,250			
110	8	—	13,800	—			

Contact Ratings

Contact	Continuous Current	Maximum Contact Capacity				
		Allowable Contact Power		Rated Load		
		Resistive Load	Inductive Load	Voltage (V)	Res. Load	Ind. Load
DPDT Slim (RY2)	3A	660 VA AC 90W DC	176 VA AC 45W DC	110V AC	3A	1.5A
				220V AC	3A	0.8A
				30V DC	3A	1.5A
DPDT Wide (RM2)	5A	1100VA AC 150W DC	440VA AC 75W DC	110V AC	5A	2.5A
				220V AC	5A	2A
				30V DC	5A	2.5A
4PDT (RY4)	5A	1200 VA AC 150W DC	288 VA AC 60W DC	240V AC	5A	1.2A
				30V DC	5A	2A
Bifurcated Contact (RY22/RY42)	1A	176 VA AC 30W DC	88 VA AC 15W DC	110V AC	1A	0.5A
				220V AC	0.8A	0.4A
				30V DC	1A	0.5A

Note: Inductive load for the rated load — $\cos \phi = 0.3$, $L/R = 7$ ms

UL Ratings (Standard Contact)

Voltage	Resistive			General use		
	DPDT Slim	DPDT Wide	4PDT	DPDT Slim	DPDT Wide	4PDT
240V AC	3A	5A	5A	0.8A	2A	5A
120V AC	—	—	—	1.5A	2.5A	—
100V DC	0.2A	0.4A	0.2A	0.2A	—	0.2A
30V DC	3A	5A	5A	3A	—	5A

CSA Ratings (Standard Contact)

Voltage	Resistive			General use		
	DPDT Slim	DPDT Wide	4PDT	DPDT Slim	DPDT Wide	4PDT
240V AC	3A	5A	5A	0.8A	2A	5A
120V AC	3A	5A	—	1.5A	2.5A	—
100V DC	—	—	—	0.2A	0.4A	0.2A
30V DC	3A	5A	5A	1.5A	2.5A	1.5A

TÜV Ratings (Standard Contact)

Voltage	DPDT Slim	DPDT Wide	4PDT
240V AC	3A	5A	5A
30V DC	3A	5A	5A

UL Ratings (Bifurcated Contact)

Voltage	Resistive	General use
240V AC	0.8A	0.4A
120V AC	1A	0.5A
30V DC	1A	0.5A

CSA Ratings (Bifurcated Contact)

Voltage	Resistive	General use
240V AC	0.8A	0.4A
120V AC	1A	0.5A
30V DC	1A	—

AC: $\cos \phi = 1.0$, DC: $L/R = 0$ ms

Switches & Pilot Lights

Display Lights

Relays & Sockets

Timers

Terminal Blocks

Circuit Breakers

Socket Specifications

	Sockets	Terminal	Electrical Rating	Wire Size	Torque
DIN Rail Mount Sockets	SY2S-05	M3 screws with captive wire clamp	300V, 7A	Maximum up to 2-#14AWG	5.5 - 9 in•lbs
	SM2S-05	M3 screw with captive wire clamp	300V, 10A	Maximum up to 2-#14AWG	5.5 - 9 in•lbs
	SY4S-05	M3 screw with captive wire clamp	300V, 7A*	Maximum up to 2-#14AWG	5.5 - 9 in•lbs
Finger-safe DIN Rail Mount	SY2S-05C	M3 screws with captive wire clamp, fingersafe	300V, 7A	Maximum up to 2-#14AWG	5.5 - 9 in•lbs
	SM2S-05C	M3 screw with captive wire clamp, fingersafe	300V, 10A	Maximum up to 2-#14AWG	5.5 - 9 in•lbs
	SY4S-05C	M3 screw with captive wire clamp, fingersafe	300V, 7A*	Maximum up to 2-#14AWG	5.5 - 9 in•lbs
Through Panel Mount Socket	SY2S-51	Solder	250V, 7A	—	—
	SM2S-51	Solder	250V, 10A	—	—
	SY4S-51	Solder	250V, 7A*	—	—
PCB Mount Socket	SY2S-61	PCB Mount	300V, 7A	—	—
	SY4S-61	PCB Mount	300V, 7A	—	—
	SY4S-62	PCB Mount	250V, 7A	—	—

Switches & Pilot Lights

Display Lights

Relays & Sockets

Timers

Terminal Blocks

Circuit Breakers



* When using only 2 poles of the 4-poles, the UL recognized current is 10A.

Characteristics (Reference Data)

Electrical Life Curves

AC Load

(RY2)

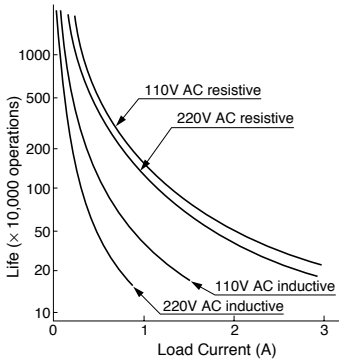

(RY4)

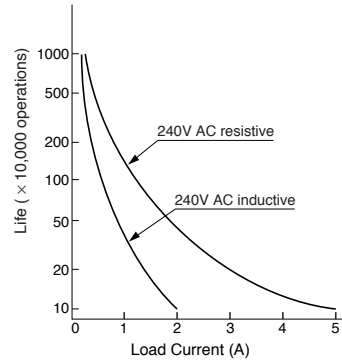

(RY42/
RY22)

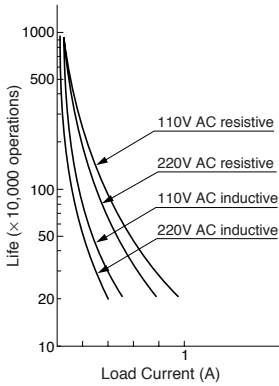

(RM2)

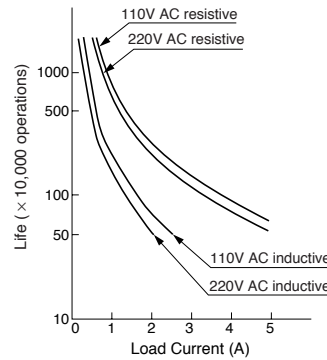

DC Load

(RY2)

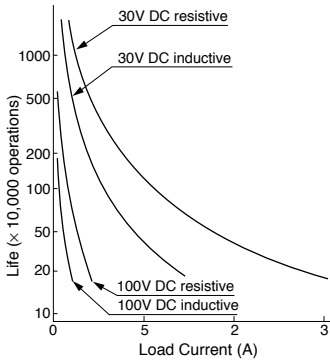

(RY4)

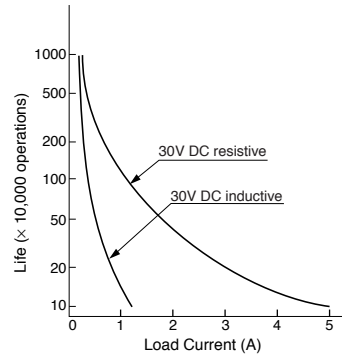

(RY42/
RY22)

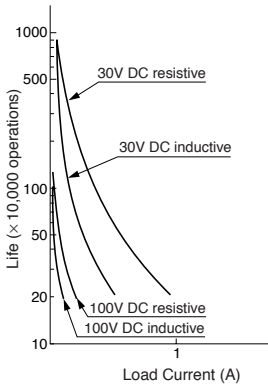

(RM2)

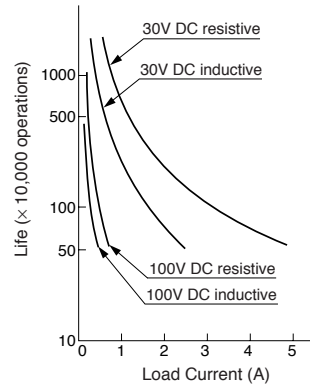

Switches & Pilot Lights

Display Lights

Relays & Sockets

Timers

Terminal Blocks

Circuit Breakers

Maximum Switching Capacity

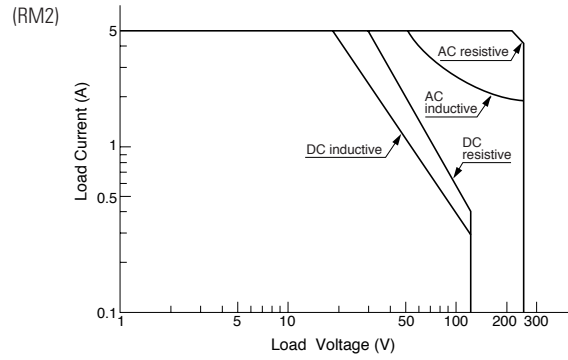
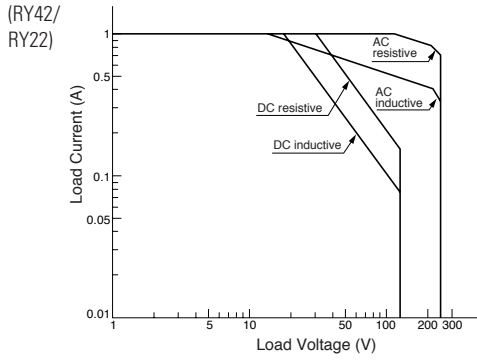
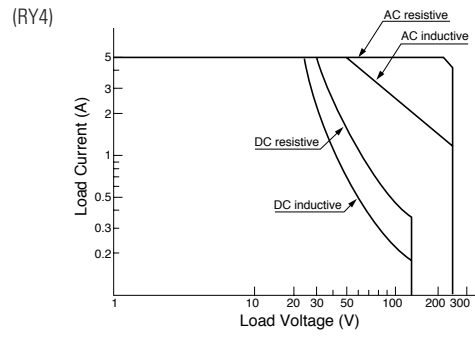
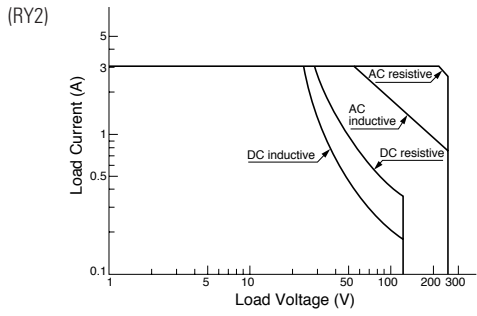

Continuous Load Current vs. Operating Temperature Curve (Basic Type, With Check Button, and Top Bracket Mounting Type)

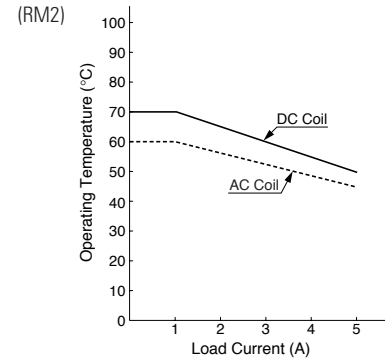
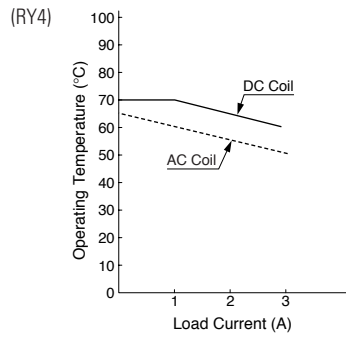
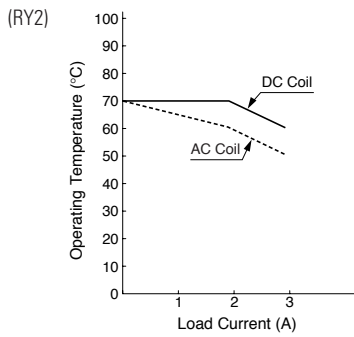

Internal Connection (View from Bottom)

Basic Type

DPDT Slim (RY2/RM22)

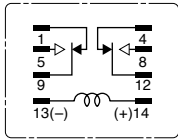

DPDT Wide (RM2)

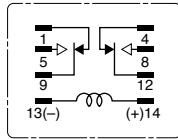

4PDT (RY4/RM42)

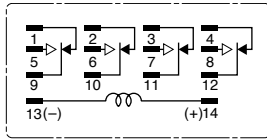

With Check Button

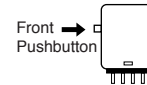

Contacts can be operated by pressing the check button.

With Indicator (-L type)

DPDT Slim (RY2/RM22)

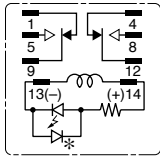

DPDT Wide (RM2)

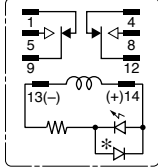

4PDT (RY4/RM42)

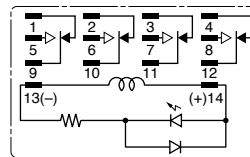

Coil Below
100V
AC/DC

Coil Below
24V
AC/DC

When the relay is energized, the indicator goes on.

- The LED protection diode is not contained in DPDT relays for coils below 100V DC.
- If coil polarity is reversed LED will not light.

Coil
100V
AC/DC
and over

Coil 24V
AC/DC
and over

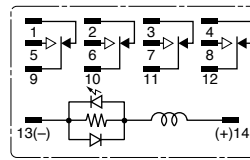
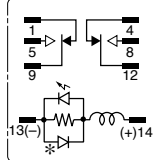

With Diode (-D type)

DPDT Slim (RY2/RM22)

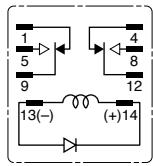

DPDT Wide (RM2)

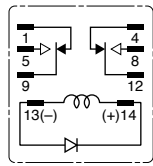

4PDT (RY4)

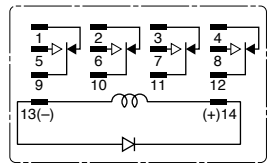

Contains a diode to absorb the back emf generated when the coil is de-energized. The release time is slightly longer.

- Diode Characteristics
Reverse withstand voltage: 1,000V
Forward current: 1A

With Indicator and Diode (-LD type)

DPDT Wide (RM2)

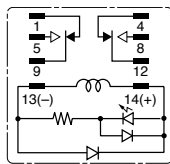

4PDT (RY4)

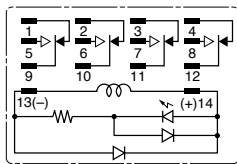

DPDT Wide (RM2)

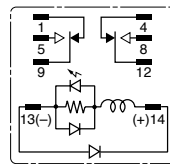

4PDT (RY4)

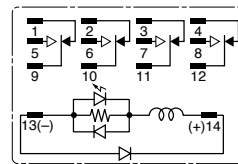

Coil Below
24V DC

Coil 24V
DC and
over

Contains LED indicator and a surge absorber.

Dimensions (mm)

RY2S/RY22S

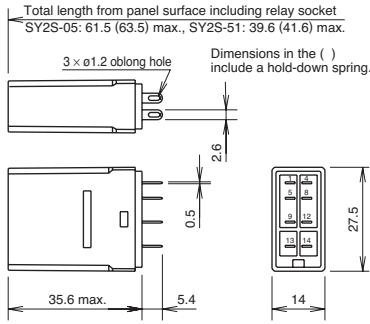

RY4S/RY42S

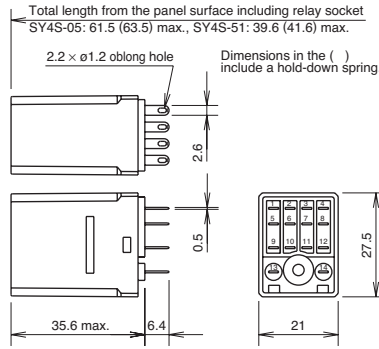

RM2S

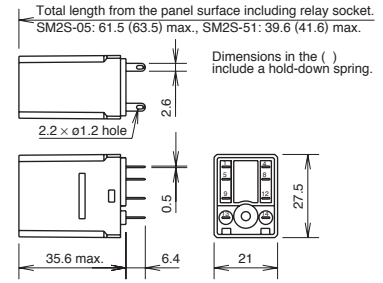

RY2V/RY22V

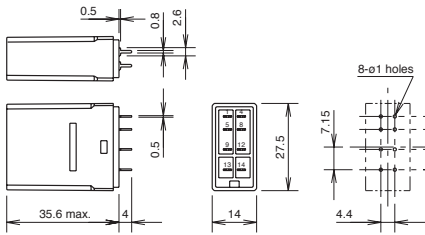

RY4V/RY42V

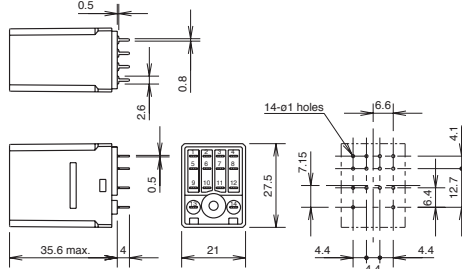

RM2V

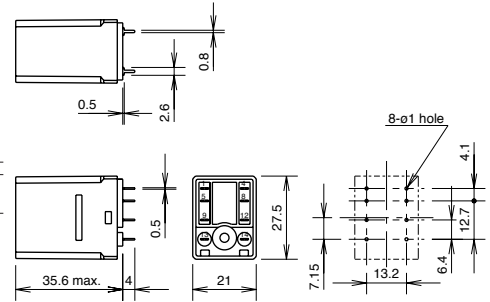

RY2S-UT/RY22S-UT

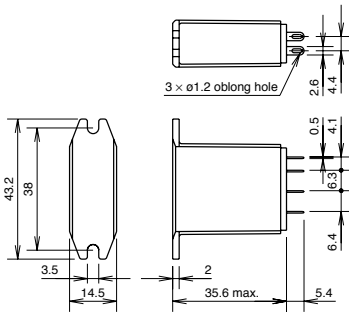

RY4S-UT/RY42S-UT

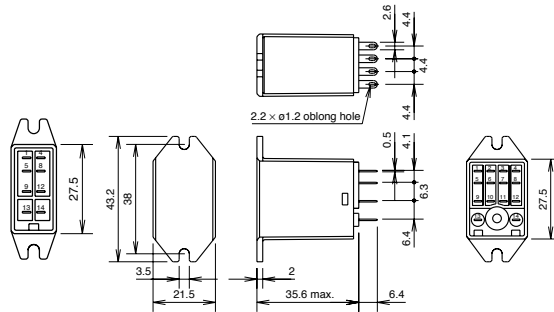

RM2S-UT

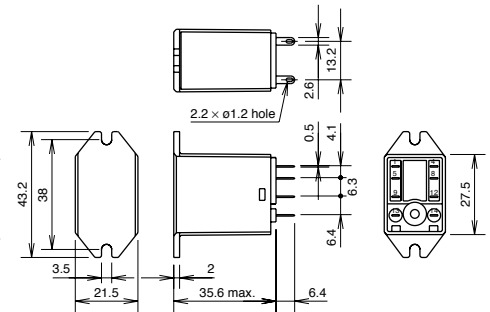

Dimensions

Standard DIN Rail Mount Sockets

SY2S-05

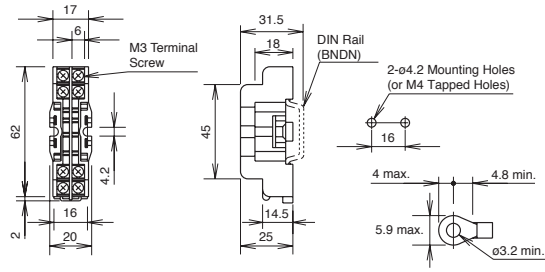

Terminal Arrangement

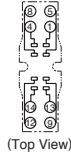

SM2S-05

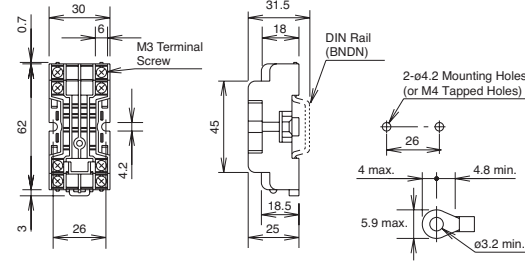

Terminal Arrangement

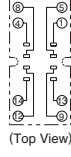

SY4S-05

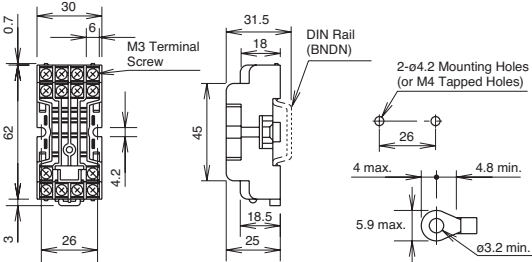

Terminal Arrangement

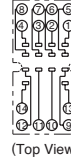

Finger-safe DIN Rail Mount Sockets

SY2S-05C

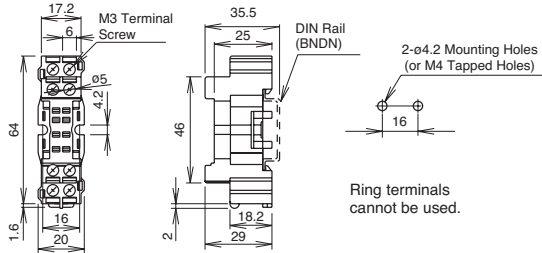

Terminal Arrangement

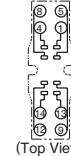

SM2S-05C

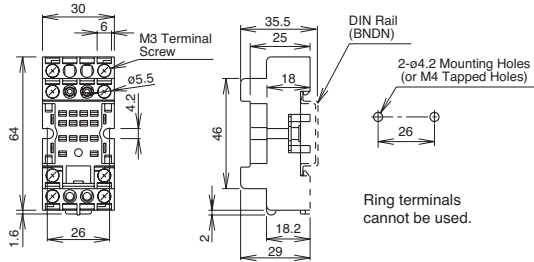

Terminal Arrangement



SY4S-05C

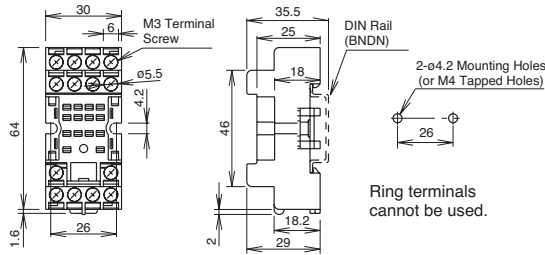

Terminal Arrangement

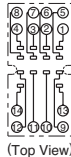

Switches & Pilot Lights

Display Lights

Relays & Sockets

Timers

Terminal Blocks

Circuit Breakers

Through Panel Mount Socket

SY2S-51

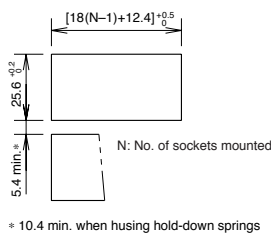
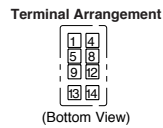
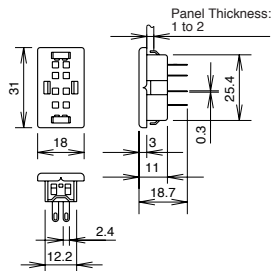

SM2S-51

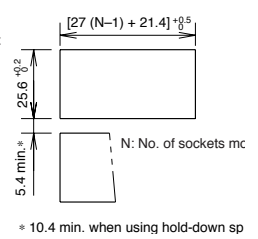
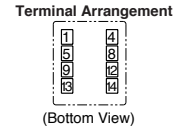
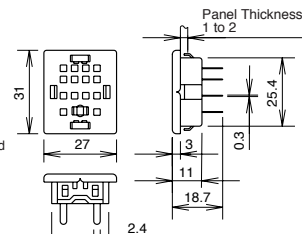

SY4S-51

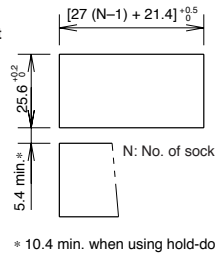
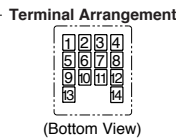
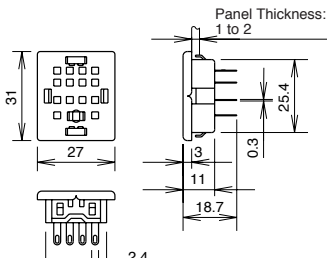

PCB Mount Sockets

SY2S-61

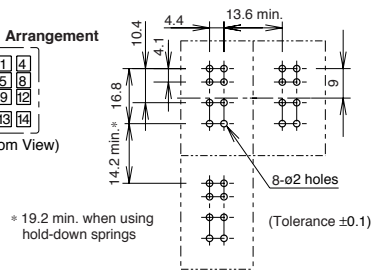
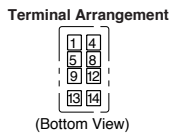
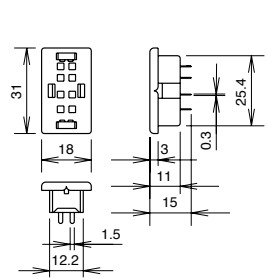

SY4S-61

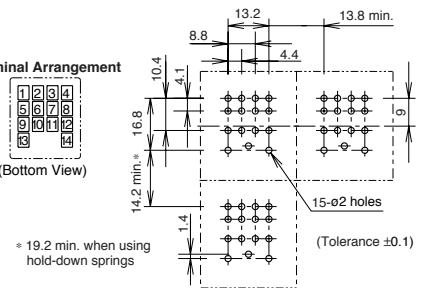
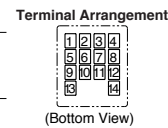
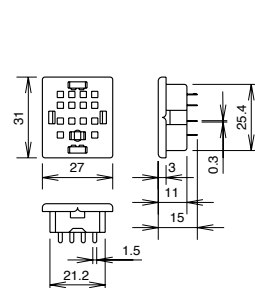

SY4S-62

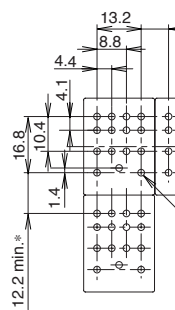
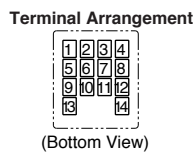
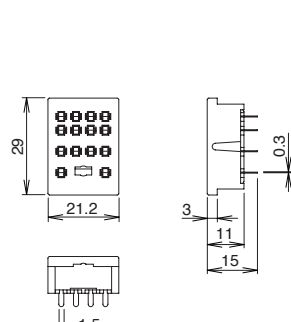

Operating Instructions

Driving Circuit for Relays

- To ensure correct relay operation, apply rated voltage to the relay coil.
- Input voltage for the DC coil:
A complete DC voltage is best for the coil power to make sure of stable relay operation. When using a power supply containing a ripple voltage, suppress the ripple factor within 5%. When power is supplied through a rectification circuit, the relay operating characteristics, such as pickup voltage and dropout voltage, depend on the ripple factor. Connect a smoothing capacitor for better operating characteristics as shown below.

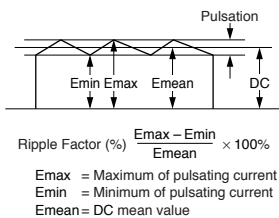
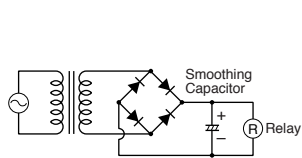

- Leakage current while relay is off:
When driving an element at the same time as the relay operation, special consideration is needed for the circuit design. As shown in the incorrect circuit below, leakage current (I_0) flows through the relay coil while the relay is off. Leakage current causes coil release failure or adversely affects the vibration resistance and shock resistance. Design a circuit as shown in the correct example.

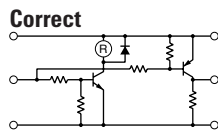
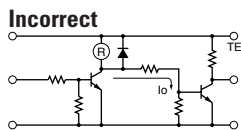

- Surge suppression for transistor driving circuits:
When the relay coil is turned off, a high-voltage pulse is generated, causing a transistor to deteriorate and sometimes to break. Be sure to connect a diode to suppress the back electromotive force. Then, the coil release time becomes slightly longer. To shorten the coil release time, connect a Zener diode between the collector and emitter of the transistor. Select a Zener voltage slightly higher than the power voltage.

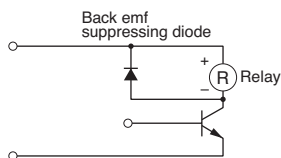

Protection for Relay Contacts

- The contact ratings show maximum values. Make sure that these values are not exceeded. When an inrush current flows through the load, the contact may become welded. If this is the case, connect a contact protection circuit, such as a current limiting resistor.
- Contact protection circuit:
When switching an inductive load, arcing causes carbides to form on the contacts, resulting in increased contact resistance. In consideration of contact reliability, contact life, and noise suppression, use of a surge absorbing circuit is recommended. Note that the release time of the load becomes slightly longer. Check the operation using the actual load. Incorrect use of a contact protection circuit will adversely affect switching characteristics. Four typical examples of contact protection circuits are shown in the following table:

RC		<p>This protection circuit can be used when the load impedance is smaller than the RC impedance in an AC load power circuit.</p> <ul style="list-style-type: none"> R: Resistor of approximately the same resistance value as the load C: 0.1 to 1 μF
Diode		<p>This protection circuit can be used for DC load power circuits. Use a diode with the following ratings.</p> <p>Reverse withstand voltage: Power voltage of the load circuit x 10</p> <p>Forward current: More than the load current</p>
Varistor		<p>This protection circuit can be used for both AC and DC load power circuits.</p> <p>For a best result, when using a power voltage of 24 to 48V AC/DC, connect a varistor across the load.</p> <p>When using a power voltage of 100 to 240V AC/DC, connect a varistor across the contacts.</p>

- Do not use a contact protection circuit as shown below:

	<p>This protection circuit is very effective in arc suppression when opening the contacts. But, the capacitor is charged while the contacts are opened. When the contacts are closed, the capacitor is discharged through the contacts, increasing the possibility of contact welding.</p>
	<p>This protection circuit is very effective in arc suppression when opening the contacts. But, when the contacts are closed, a current flows to charge the capacitor, causing contact welding.</p>

Generally, switching a DC inductive load is more difficult than switching a DC resistive load. Using an appropriate arc suppressor, however, will improve the switching characteristics of a DC inductive load.

Soldering

- When soldering the relay terminals, use a soldering iron of 30 to 60W, and quickly complete soldering (within approximately 3 seconds).
- Use a non-corrosive rosin flux.

Operating Instructions con't

Other Precautions

1. General notice:

To maintain the initial characteristics, do not drop or shock the relay.

The relay cover cannot be removed from the base during normal operation. To maintain the initial characteristics, do not remove the relay cover.

Use the relay in environments free from condensation, dust, sulfur dioxide (SO₂), and hydrogen sulfide (H₂S).

Make sure that the coil voltage does not exceed applicable coil voltage range.

2. UL and CSA ratings may differ from product rated values determined by IDEC.

3. Do not use relays in the vicinity of strong magnetic field, as this may affect relay operation.

Safety Precautions

- Turn off the power to the relay before starting installation, removal, wiring, maintenance, and inspection of the relays. Failure to turn power off may cause electrical shock or fire hazard.
- Observe specifications and rated values, otherwise electrical shock or fire hazard may be caused.
- Use wires of the proper size to meet voltage and current requirements. Tighten the terminal screws on the relay socket to the proper tightening torque.
- Surge absorbing elements on AC relays with RC or DC relays with diode are provided to absorb the back electromotive force generated by the coil. When the relay is subject to an excessive external surge voltage, the surge absorbing element may be damaged. Add another surge absorbing provision to the relay to prevent damage.

Precautions for the RU Relays

- Before operating the latching lever of the RU relay, turn off the power to the RU relay. After checking the circuit, return the latching lever to the original position.
- Do not use the latching lever as a switch. The durability of the latching lever is a minimum of 100 operations.
- When using DC loads on 4PDT relays, apply a positive voltage to terminals of neighboring poles and a negative voltage to the other terminals of neighboring poles to prevent the possibility of short circuits.
- DC relays with a diode have a polarity in the coil terminals. Apply the DC voltage to the correct terminals.

RR2KP Series Latch Relays

**Self-maintained Latch Relays
DPDT — 10A contact capacity**

The RR2KP series latch relays have a self-holding function using permanent magnets in the magnetic circuit. Applying a voltage on the set (or reset) coil operates the armature and retains the contacts in that position until the opposite coil is energized, hence the latch relays are ideal for memory and flip-flop circuit applications.



- Enhanced self-holding functions, and vibration and shock resistance.
- The self-holding mechanism is not subject to wear unlike mechanical latch relays.
- Recognized by UL and certified by CSA



Part Number Selection



Contact	Model	Part Number	
		Pin Terminal	Coil Voltage Code
 DPDT	Basic	RR2KP-U	AC6, AC12, AC24, AC110, AC120, AC220, AC240 DC6, DC12, DC24, DC48, DC110
	With Check Button	RR2KP-UC	

Ordering Information

When ordering, specify the Part No. and coil voltage code:

(example) **RR2KP-U** **AC120**
Part No. Coil Voltage Code

Sockets

Relay	DIN Rail Mount	Finger-safe DIN Rail Mount	Panel Mount
RR2KP	SR3P-05 SR3P-06	SR3P-05C	SR3P-51
			

Springs & Clips (optional)	
Part Number	Description
SR3P-06F3	use with SR3P-05 SR3P-05C SR3P-06
SR3P-51F3	use with SR3P-51

Switches & Pilot Lights

Display Lights

Relays & Sockets

Timers

Terminal Blocks

Circuit Breakers

Specifications

Contact Material	Silver	
Contact Resistance	30 mΩ maximum (initial value)	
Operate Time	25 ms maximum (at the rated voltage)	
Power Consumption (approx.)	AC: 2.4 VA (50 Hz), 2.2 VA (60 Hz) DC: 1.5W	
Insulation Resistance	100 MΩ minimum (500V DC megger)	
Dielectric Strength	Between live and dead parts: 1,500V AC, 1 minute Between contact and coil: 1,500V AC, 1 minute Between contacts of different poles: 1,500V AC, 1 minute Between contacts of the same pole: 1,000V AC, 1 minute	
Operating Frequency	Electrical:	1800 operations/h maximum
	Mechanical:	18,000 operations/h maximum
Temperature Rise	Coil: 85°C maximum, Contact: 65°C maximum	
Vibration Resistance	0 to 60 m/s ² (maximum frequency: 55 Hz), Frequency: 5 to 55 Hz, Amplitude: 0.5 mm	
Shock Resistance	100 m/s ² minimum	
Mechanical Life	5,000,000 operations minimum	
Electrical Life	500,000 operations minimum (110V AC, 10A)	
Operating Temperature	-5 to +40°C (no freezing)	
Operating Humidity	45 to 85% RH (no condensation)	
Weight (approx.)	170g	

Coil Ratings

Rated Voltage (V)	Rated Current (mA) ±15% at 20°C		Coil Resistance (Ω) ±10% at 20°C	Operation Characteristics (values at 20°C)	
	50Hz	60Hz		Maximum Continuous Applied Voltage	Set and Reset Voltage
AC (50/60Hz)	6	467	429	110%	80% maximum
	12	200	184		
	24	100	92		
	110	23	21		
	120	24	22		
	220	10.9	10		
	240	11.5	10.6		
DC	6	240		110%	80% maximum
	12	120			
	24	60			
	48	30			
	110	13.8			

Contact Ratings

Switching Voltage	Continuous Current	Maximum Contact Capacity				
		Allowable Contact Power		Rated Load		
		Resistive Load	Inductive Load	Voltage (V)	Res. Load	Ind. Load
250V AC 125V DC	10A	1650VA AC 300W DC	1100VA AC 225W DC	110 AC	10A	7.5A
				220 AC	7.5A	5A
				30 DC	10A	5A
				100V DC	0.5A	0.3A

Note: Inductive load for the rated load — cos φ = 0.3, L/R = 7 ms

UL Ratings

Voltage	Resistive	General use	Motor Load
240V AC	10A	7A	1/3 HP
120V AC	10A	7.5A	1/4 HP
30V DC	10A	7A	—

CSA Ratings

Voltage	Resistive	General use	Motor Load
240V AC	10A	7A	1/3 HP
120V AC	10A	7.5A	1/4 HP
100V DC	—	0.5A	—
30V DC	10A	7.5A	—

Switches & Pilot Lights

Display Lights

Relays & Sockets

Timers

Terminal Blocks

Circuit Breakers

Socket Specifications

	Relays	Terminal	Electrical Rating	Wire Size	Torque
DIN Rail Mount Sockets	SR3P-05	M3 screw with captive wire clamp	300V, 10A	2-#12AWG	9 - 11.5 in•lbs
	SR3P-05C	M3 screw with captive wire clamp, fingersafe	300V, 10A	2-#12AWG	9 - 11.5 in•lbs
	SR3P-06	M3 screw with captive wire clamp	300V, 10A	2-#12AWG	9 - 11.5 in•lbs
Through Panel Mount Socket	SR3P-51	Solder	300V, 10A	—	—

Electrical Life Curve
AC Load

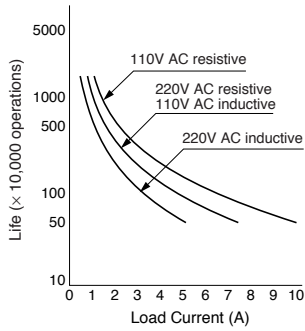

DC Load

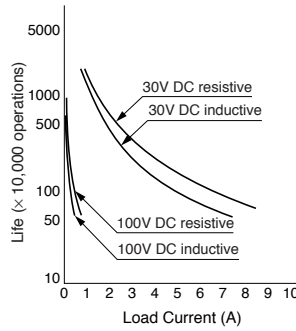

Internal Connection (View from Bottom)
(Shown in unlatched/reset position)

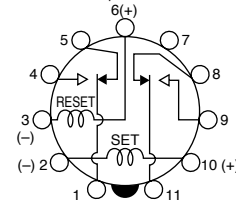

Dimensions (mm)

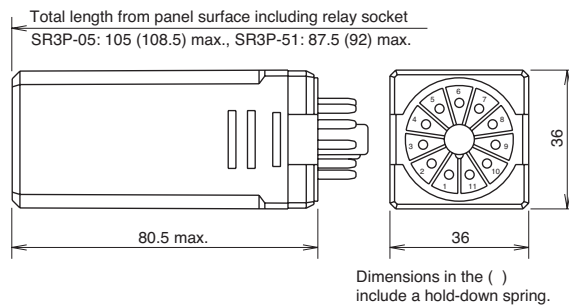

Standard DIN Rail Mount Sockets
SR3P-05

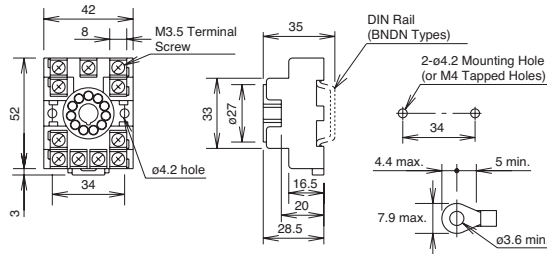

SR3P-06

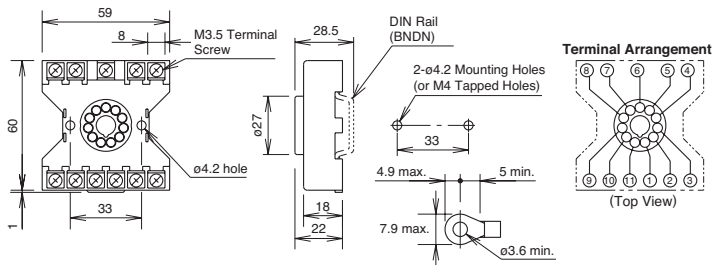

Finger-safe DIN Rail Mount Sockets
SR3P-05C

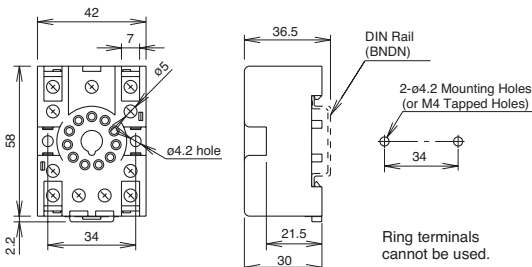

Through Panel Mount Socket
SR3P-51

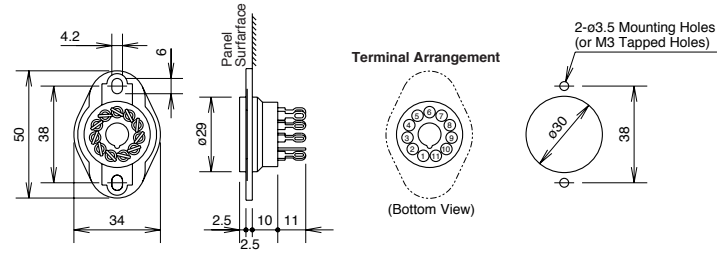

RY2KS Series Latch Relays

Self-maintained Latch Relays DPDT — 3A contact capacity

The RY2KS series latch relays have a self-holding function using permanent magnets in the magnetic circuit. Applying a voltage on the set (or reset) coil operates the armature and retains the contacts in that position until the opposite coil is energized, hence the latch relays are ideal for memory and flip-flop circuit applications.



Switches & Pilot Lights

Display Lights

Relays & Sockets

Timers

Terminal Blocks

Circuit Breakers



Part Number Selection





Contact	Model	Part Number	
		Blade Terminal	Coil Voltage Code
DPDT 	Basic	RY2KS-U*	AC6, AC12, AC24, AC110 DC6, DC12, DC24, DC48, DC110
	With Check Button	RY2KS-UC*	

Ordering Information

When ordering, specify the Part No. and coil voltage code:

(example) **RY2KS-U** **AC120**
Part No. Coil Voltage Code

Sockets

Relay	DIN Rail Mount	Finger-safe DIN Rail Mount	Panel Mount	PCB Mount
RY2KS	SY4S-05	SY4S-05C	SY4S-51	SY4S-61 SY4S-62
				

Springs & Clips (optional)	
Part Number	Description
SFA-202	use with SY4S-05 SY4S-05C
SY4S-51F1 (SY4S-02F3) SFA-302	use with SY4S-51 SY4S-61
SY4S-51F3 SY4S-02F3	use with SY4S-62



Notes:

- For the relays with check button, use the parenthesized hold-down springs shown in the above table. When the spring is used, sockets cannot be mounted closely side by side.
- Use the hold-down springs in environments where the relays are subject to vibrations or shocks.

Specifications

Contact Material	Gold-plated silver
Contact Resistance	50 mΩ maximum (initial value)
Set Time	25 ms maximum (at the rated voltage)
Reset Time	25 ms maximum (at the rated voltage)
Power Consumption (approx.)	AC: 1.6 VA (50 Hz), 1.5 VA (60 Hz) DC: 1.2W
Insulation Resistance	100 MΩ minimum (500V DC megger)
Dielectric Strength	Between live and dead parts: 1,500V AC, 1 minute Between contact and coil: 1,000V AC, 1 minute Between contacts of different poles: 1,000V AC, 1 minute Between contacts of the same pole: 700V AC, 1 minute
Operating Frequency	Electrical: 1800 operations/h maximum Mechanical: 18,000 operations/h maximum
Temperature Rise	Coil: 85°C maximum, Contact: 65°C maximum
Vibration Resistance	0 to 60 m/s ² (maximum frequency: 55 Hz), Frequency: 5 to 55 Hz, Amplitude: 0.5 mm
Shock Resistance	200 m/s ² minimum
Mechanical Life	5,000,000 operations minimum
Electrical Life	200,000 operations minimum
Operating Temperature	-5 to +40°C (no freezing)
Weight (approx.)	67g

Coil Ratings

Rated Voltage (V)	Rated Current (mA) ±15% at 20°C		Coil Resistance (Ω) ±10% at 20°C	Operation Characteristics (values at 20°C)	
	50Hz	60Hz		Maximum Continuous Applied Voltage	Set and Reset Voltage
AC (50/60Hz)	6	260	250	110%	80% maximum
	12	120	115		
	24	58	56		
	120	11.2	10.8		
DC	6	200		110%	80% maximum
	12	100			
	24	50			
	48	25			
	110	11			

Contact Ratings

Switching Voltage	Continuous Current	Maximum Contact Capacity				
		Allowable Contact Power		Rated Load		
		Resistive Load	Inductive Load	Voltage (V)	Res. Load	Ind. Load
250V AC 125V DC	3A	600VA AC 90W DC	176VA AC 45W DC	110 AC	3A	1.5A
				220 AC	3A	0.8A
				30 DC	3A	1.5A
				100V DC	0.2A	0.12A

UL Ratings

Voltage	Resistive	General use
240V AC	3A	0.8A
120V AC	3A	1.5A
30V DC	3A	—

CSA Ratings

Voltage	Resistive	General use
240V AC	3A	0.8A
120V AC	3A	1.5A
30V DC	3A	1.5A



 Note: Inductive load for the rated load — $\cos \phi = 0.3$, L/R = 7 ms

Socket Specifications

	Sockets	Terminal	Electrical Rating	Wire Size	Torque
DIN Rail Mount Sockets	SY4S-05	M3 screw with captive wire clamp	300V, 7A	Maximum up to 2-#14AWG	5.5 - 9 in • lbs
	SY4S-05C	M3 screw with captive wire clamp, fingersafe	300V, 7A	Maximum up to 2-#14AWG	5.5 - 9 in • lbs
Through Panel Mount Socket	SY4S-51	Solder	300V, 7A	—	—
PCB Mount Sockets	SY4S-61	Solder/PCB Mount	300V, 7A	—	—
	SY4S-62	Solder/PCB Mount	250V, 7A	—	—

Electrical Life Curve

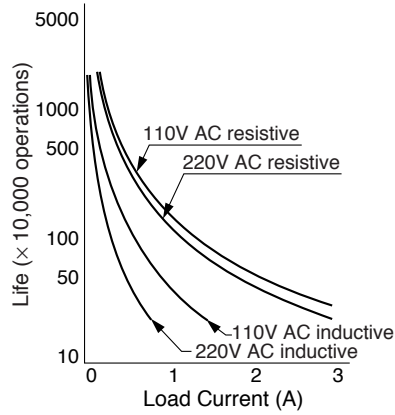
AC Load



DC Load

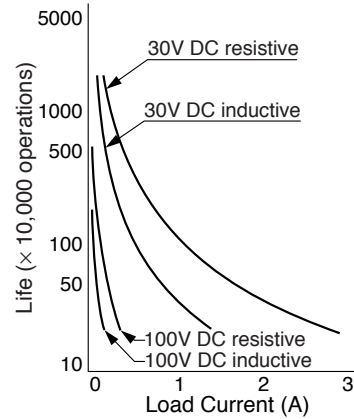

Internal Connection (View from Bottom)

(Shown in unlatched/reset position)

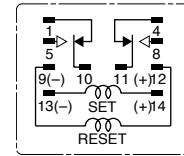

Dimensions (mm)

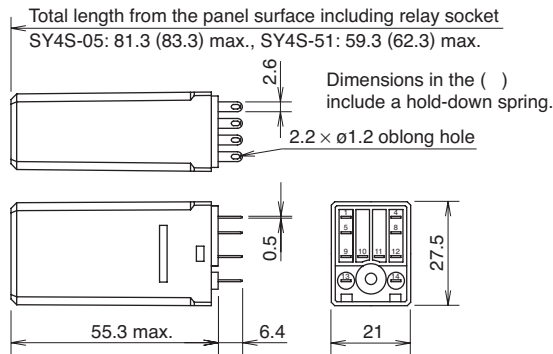

Standard DIN Rail Mount Socket

SY4S-05

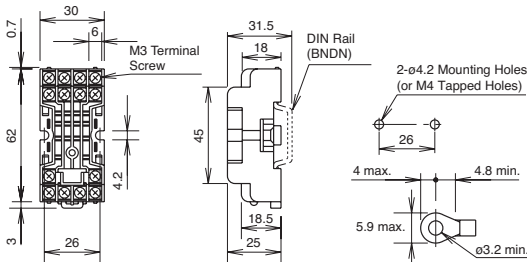

Finger-safe DIN Rail Mount Socket

SY4S-05C

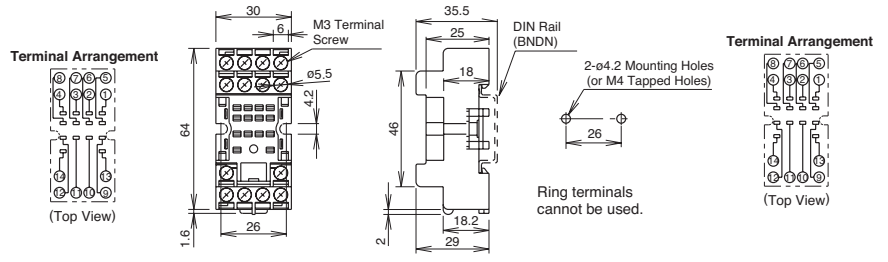

Through Panel Mount Socket

SY4S-51

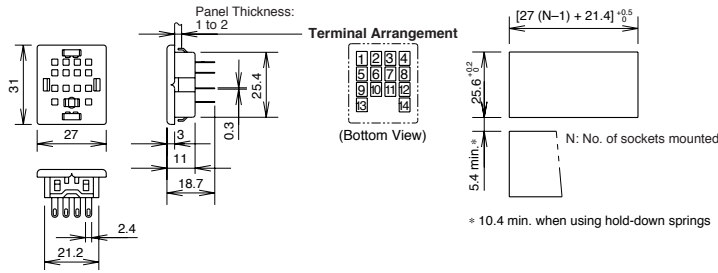

PCB Mount Sockets

SY4S-61

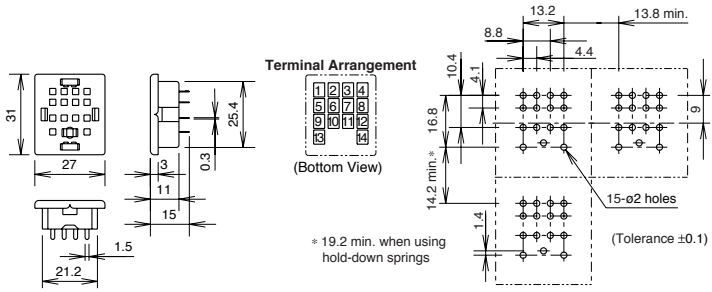

SY4S-62

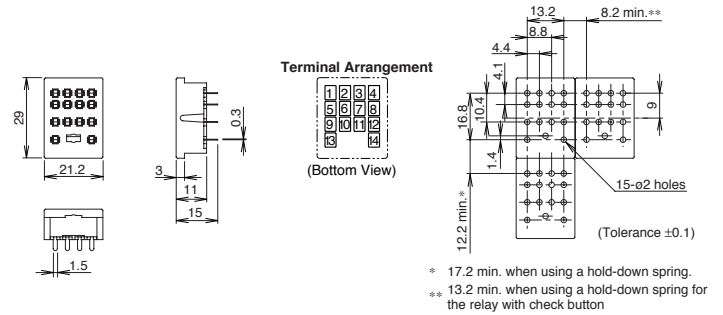

Switches & Pilot Lights

Display Lights

Relays & Sockets

Timers

Terminal Blocks

Circuit Breakers

RSC Series Solid State Relays

Key features of the RSC series include:

- Slim design allows for DIN rail or panel mounting
- Built-in heat sink maximizes current output capability
- Epoxy-free design
- Choice of 20A, 30A and 45A models
- LED indicator
- Finger-safe terminals
- Zero voltage switching
- Back-to-back SCR output
- Direct Bond Copper (DBC) substrate construction
- Built-in transient protection (TVS)
- 100k-cycle UL508 endurance rating
- UL Recognized, CSA Certified, TUV Approved, CE Marked
- Lead free and RoHS compliant
- EMC (Level 3) & IEC 62314 compliant



Switches & Pilot Lights

Display Lights



UL Recognized
File No. E194577



Part Number Selection

Input Control Voltage	Output Current Rating	Part Number
4-32V DC	20A	RSCDN-20A
	30A	RSCDN-30A
	45A	RSCDN-45A
90-140V AC	20A	RSCA1N-20A
	30A	RSCA1N-30A
	45A	RSCA1N-45A
180-280V AC	20A	RSCA2N-20A
	30A	RSCA2N-30A
	45A	RSCA2N-45A*



*Input control voltage is 180-260V AC.

Specifications

	Model	20A	30A	45A
General Characteristics	Operating temperature (°C)	-20 to +80 -20 to +60 (90-140 V AC input models)		
	Storage temperature (°C)	-40 to +100		
	Input-to-Output isolation voltage (Vrms)	4200		
	Input/Output to ground isolation voltage (Vrms)	4000		
	Operating frequency (Hz)	47 to 63		
	Housing material	UL94-V0 Self-extinguishing polycarbonate		
	Heat sink material	Anodized aluminum black		
	Protection (IEC 60529) - Casing	IP20		
	Input terminal wire size (stranded and solid)	16 AWG to 24 AWG		
	Input terminal tightening torque (Nm)	0.5		
	Output terminal wire size (stranded)	8 AWG to 16 AWG		
	Output terminal wire size (solid)	10 AWG to 16 AWG		
	Output terminal tightening torque (Nm)	1.3		
	Weight (g)		225	400

Relays & Sockets

Timers

Terminal Blocks

Circuit Breakers

Specifications con't

Switches & Pilot Lights

Display Lights

Relays & Sockets

Timers

Terminal Blocks

Circuit Breakers

	Model	20A	30A	45A
Safety Standards	Conformity to standards	IEC 62314 IEC 60947-4-2 (AC 53a) TUV certified per EN 60950	IEC 60947-4-3 (AC 51) CE compliant with LVD 73/23/EEC CSA certified per C22.2.no. 14-95	UL recognized per UL 508
	Vibrations according to IEC/EN60068-2-6	35 mm / 10-55 Hz		
	Shock test IEC 60068-2-27	15 G / 11 ms		
	Immunity to electrostatic discharges IEC/EN 61000-4-2	Level 3		
	Immunity to electrostatic fields ENV 50140/204 (IEC 1000-4-3)	Level 3		
	Immunity to rapid transient bursts to IEC 1000-4-4	Level 3		
	Immunity to shock waves according to IEC/EN 61000-4-5	Level 3		
	Immunity to radio frequency in common mode acc. to ENV (CEI 1000-4-6)	Level 3		
	Conducted and radiated noise for industrial environments per CISPR 11	Class A		
	Pollution	Degree 2		
Overvoltage	Category III			

	Model	20A, 30A, 45A		
Input Specifications	Input voltage (V)	4-32V DC	90-140V AC	180-280V AC*
	Turn-off voltage (V)	1	10	10
	Max. controlled current (mA)	20	6	8
	Min. input current (mA)	16	5	6
	Turn-on time (ms)	8.33 (60Hz) / 10 (50Hz)	30	30
	Max. turn-off time (ms)	8.33 (60Hz) / 10 (50Hz)	30	30

1. LED is not an absolute indicator of power being present.
 2. *45A model is 180-260V AC

	Model	20A	30A	45A
Output Specifications	Voltage range (Vrms max)	48-600	48-600	48-600
	Non-rep. peak voltage (Vpeak)	1100	1100	1100
	Maximum off-state leakage at Vmax and T = 25 °C (µA)	120	120	120
	Current max @ 40°C (A)	20	30	45
	Minimum current (mA)	100	100	100
	On-state voltage drop at I max (Vpeak)	1.2	1.2	1.35
	I ² t (t = 10 ms) (A ² s) (50/60 Hz)	1225/1020	2850/2350	3200/2600
	Static (off-state) dv/dt (V/µs)	500	500	500
	HP ratings at 120V	1/2	3/4	1.5
	HP ratings at 240V	1	2	3
	HP ratings at 480V	–	–	5
	Utilization category AC-51 (A)	20	30	45
	Utilization Category AC-53 (A)	6	9	10
	Max. non-rep. 1 s surge (T=25°C) (A)	100	150	160
	Max. non-rep. 1-cycle surge (T=25°C) (A)	495	750	800

Dimensions (mm)

20A/30A Models

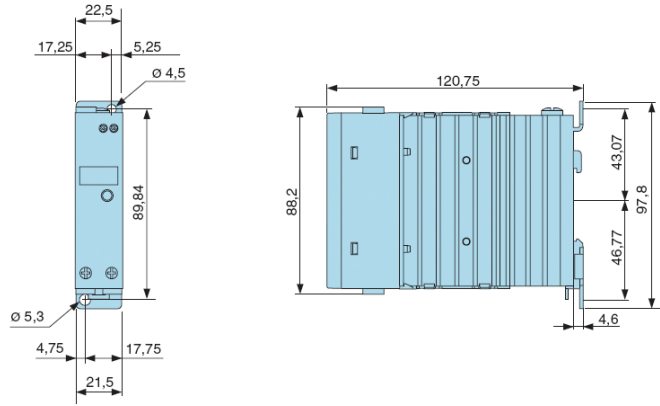

45A Model

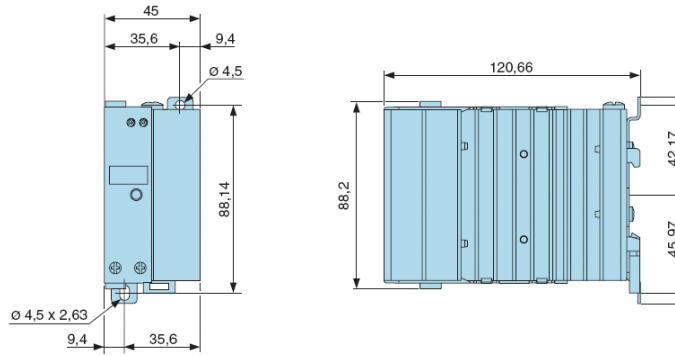

RSS Series DIN Panel Mount Solid State Relays

Key features of the RSS series include:

- Input status LED Indicator
- Dual SCR output
- Direct bond copper substrate
- Internal transient protection – built-in snubber
- EMC compliant (level 3)
- Photo isolation
- 1200 volt blocking voltage
- 4000 volt optical isolation
- Zero voltage turn-on
- High surge capability
- Optional fingersafe terminal cover (RSS-CVR)



UL Recognized
File No. E194577



Part Number Selection

Input	Continuous Output Current	Part Number
AC Input 90-280V AC	10A	RSSAN-10A
	25A	RSSAN-25A
	50A	RSSAN-50A
	75A	RSSAN-75A
	90A	RSSAN-90A
DC Input 4-32V DC	10A	RSSDN-10A
	25A	RSSDN-25A
	50A	RSSDN-50A
	75A	RSSDN-75A
	90A	RSSDN-90A

Specifications

	Series	RSSDN			RSSAN	
Input Specifications	Voltage Range	4 to 32V DC			90 to 280V AC	
	Input Current	current regulated (10mA)				
	Pick Up Voltage	4V DC			90V AC	
	Drop Out Voltage	1V DC			10V AC	
	Dielectric Strength (Input-Output-Base)	4000 RMS (min)			4000 RMS (min)	
	Capacitance (Input to Output)	8pF			8pF	
	Rev. Voltage Protection	Yes (-32VDC)			N/A	
Output Specifications	Current (continuous)	10A	25A	50A	75A	90A
	1-Cycle Surge Current	150A	300A	750A	1000A	1200A
	1-Second Surge Current	30A	75A	150A	225A	300A
	Minimum Holding Current	50mA	50mA	100mA	100mA	100mA
	Voltage Drop at Rated Current	1.6V (maximum)				
	Voltage Range	48 - 660V AC				
	Output	Dual SCR (N.O.)				
	Over Voltage Rating	1200 PIV				
	Frequency Range	47 to 80Hz				
	Off-State Leakage at Rated Voltage	20mA (maximum)				
	Turn-On Time	1/2 cycle @ 60Hz				
	Turn-Off Time	1/2 cycle @ 60Hz				
	Zero Voltage Switching	Yes				
Static DV/DT	200V/µsec					
Commutating DV/DT	Snubbed for 0.5 power factor at rated load					
Weight	10g (approx.)					

Switches & Pilot Lights

Display Lights

Relays & Sockets

Timers

Terminal Blocks

Circuit Breakers

Recommended Loads

Transformer Loads

Transformer loads sometimes result in severe inrush current when the transformer saturates during the first cycle. Use a relay rated for this surge, which has a 1/2 cycle surge current greater than the maximum applied line voltage; the transformer's primary resistance (approximately 10x rated current).

Recommended Loads

SSR Rating	at 120V AC	at 240V AC
10A	500VA	1KVA
25A	1KVA	2KVA
50A	2KVA	4KVA

Heater Loads

When using solid state relays for driving heaters where the load is switched on and off rapidly and continuously, severe thermal stress will result. In such cases, use an SSR relay at no more than 75% of the rating.

Recommended Loads

SSR Rating	at 120V AC	at 240V AC
10A	1KW	2KW
25A	2KW	4KW
50A	3KW	6KW

Solenoid Valves and Contactors

RSS relays use high-noise immunity circuitry with a built-in snubber to handle the electrical noise generated by inductive loads.

Recommended Loads

SSR Rating	at 120V AC	at 240V AC
10A	900W	1,800W
25A	2,100W	4,200W
50A	3,800W	7,500W

RSS series relays provide a highly reliable means of switching AC loads when applied properly. Read the technical notes on the following page prior to installing solid state relays.

UL Motor Load Ratings (HP Ratings)

Part Number	120V	240V	480V
10A	1/2	3/4	3/4
25A	1/2	3/4	3/4
50A	3/4	1 1/2	1 1/2
75A	3/4	5	5
90A	3/4	5	5

Lamp Loads

Zero voltage switching is ideal for driving incandescent lamps, since the cold filament will not be subjected to a large inrush current. Using a zero-switched SSR will reduce inrush current and prolong lamp life.

Recommended Loads

SSR Rating	at 120V AC	at 240V AC
10A	1KW	2KW
25A	2KW	4KW
50A	3KW	6KW

Internal Circuit Block Diagram

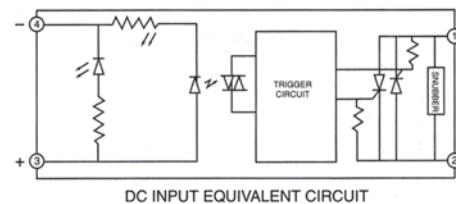
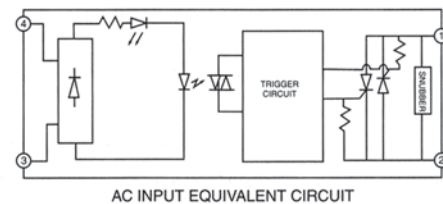

Technical Notes

Environment

Do not install SSRs near sources of excessive heat. Make sure applications are dry and well ventilated.

If SSRs must be installed in an environment subject to high temperatures or poor ventilation, or if SSRs are mounted collectively, reduce the load current so that it does **not** approach the ambient temperature-load current recommendation. (See the Temperature Derating Curves on the following page.)

When SSRs are used with inductive loads, suppress the inrush current to half of the peak surge current.

Heat Sinks

Heat sinks are recommended for all solid state relays depending on ambient temperature and mounting position. The recommended heat sink dimensions and material are shown in the table:

Output Rating	Dimensions	Material
10A	12" x 12" x 1/8"	Aluminum (black anodized)
25A	12" x 12" x 1/8" (DC/AC)	Aluminum (black anodized)
25A	15" x 15" x 1/8" (AC/AC)	Aluminum (black anodized)
50A	15" x 15" x 1/8"	Aluminum (black anodized)
75A	17" x 17" x 1/8"	Aluminum (black anodized)
90A	17" x 17" x 1/8"	Aluminum (black anodized)

Using a thermal compound between the base of the SSR and the heat sink for heat dissipation is recommended.

Wiring

Locate SSRs as far from motor leads as possible to prevent malfunction from induced current.

Use shielded wires for input leads when they are exposed to a source of induced current.

Mounting

Provide sufficient ventilation.

Use #6 – 32 screws, flat washers, and lock washers to secure mounting on heat sinks.

Vertical mounting is recommended to allow air to flow unimpeded. Horizontal or inverted mounting is possible, but the SSR must be derated according to the derating curves on the following page.

Additional Information

Do not exceed the load voltage and current specifications.

A small-capacity load may not turn off due to the leakage current present after the SSR has turned off. If this is the case, use a resistor in parallel with the load to shunt the leakage current.

Observe the polarity of input terminals. Failure to do so may cause damage to the SSR.

When the SSR output is subjected to a higher than rated voltage, a varistor or other element should be connected to the output terminals to absorb the over-voltage.

When the input signal contains a ripple voltage, the lowest ripple amplitude should exceed the minimum pick-up voltage of 4V.

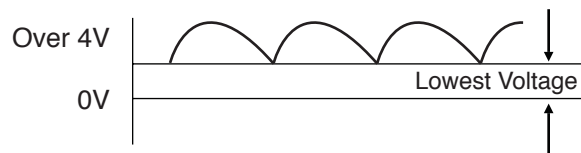

Switches & Pilot Lights

Display Lights

Relays & Sockets

Timers

Terminal Blocks

Circuit Breakers

Temperature Derating Curves: RSS Series

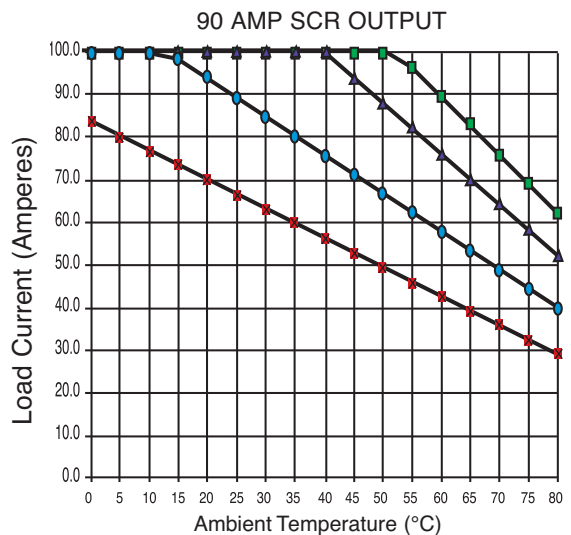
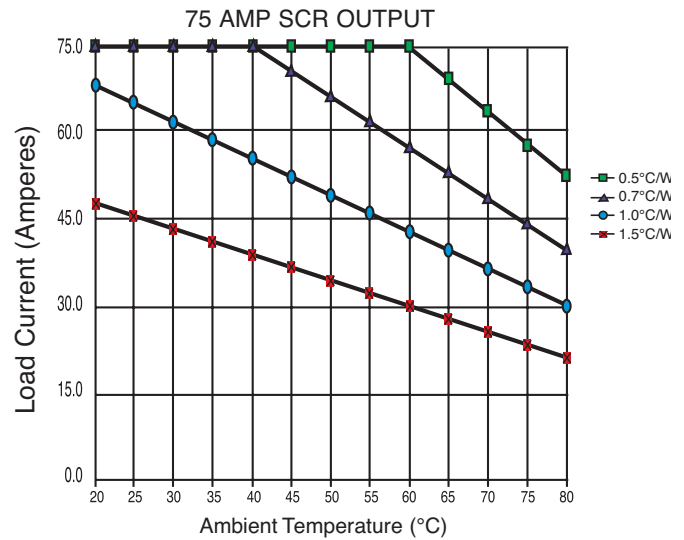
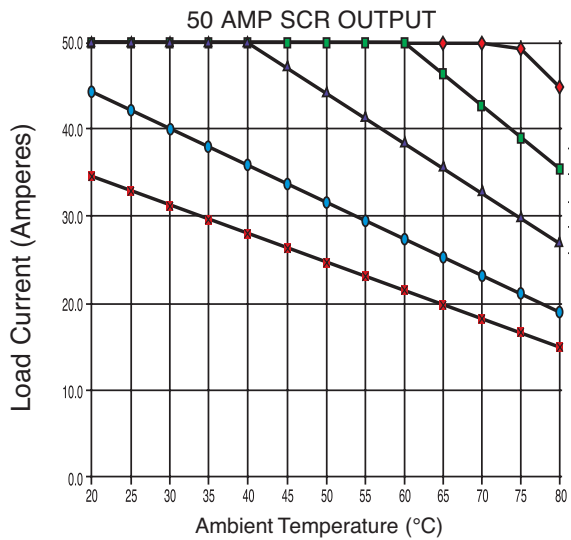
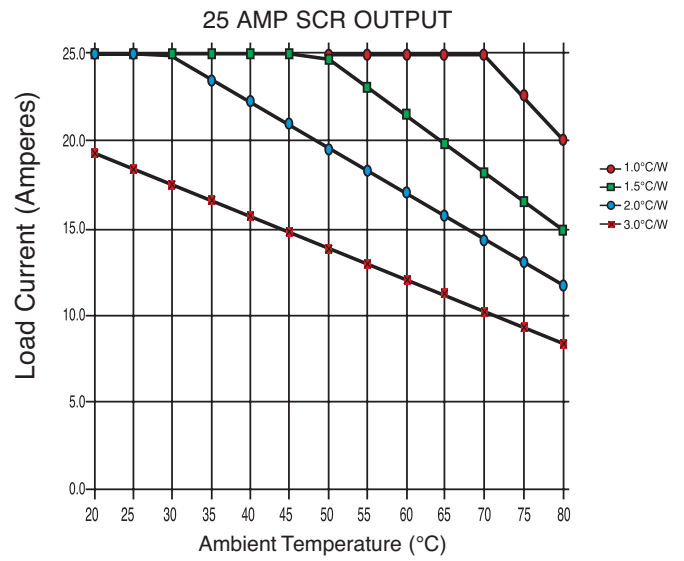
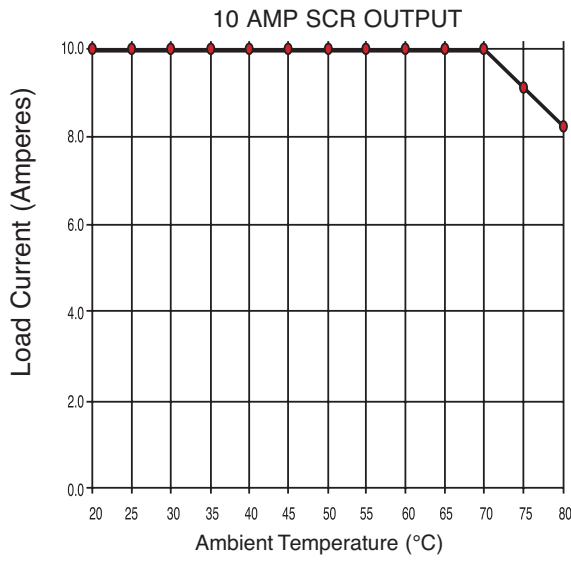

Switches & Pilot Lights

Display Lights

Relays & Sockets

Timers

Terminal Blocks

Circuit Breakers

Dimensions (mm)

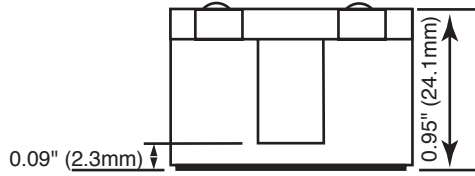
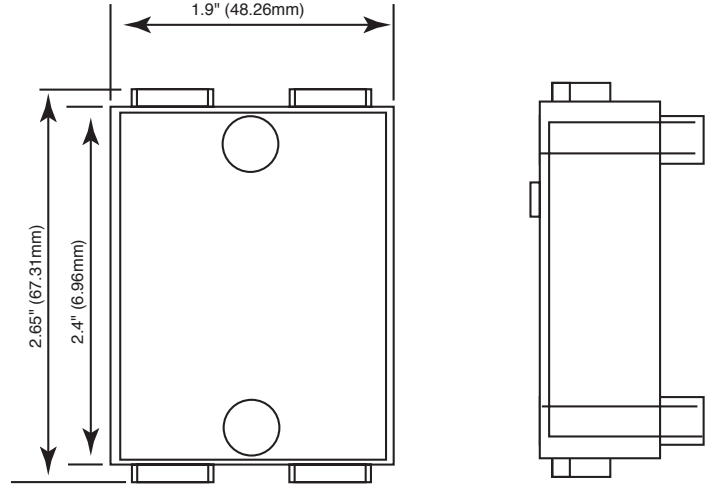
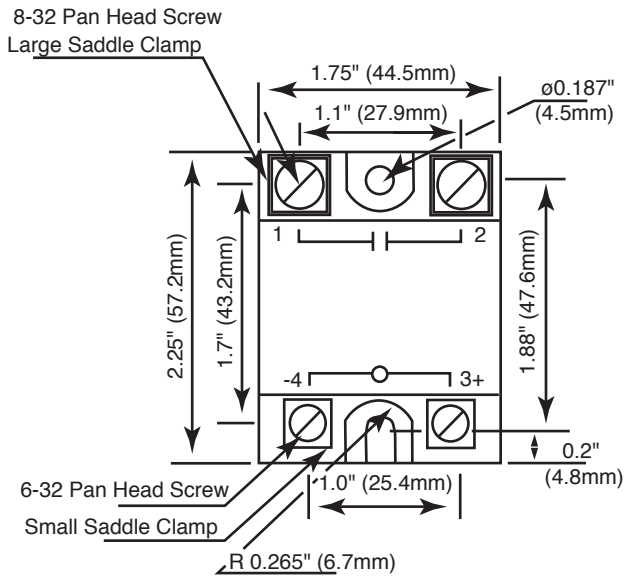

RSS-CVR - Optional Fingersafe Cover

