

# General Specifications

## Electrical Capacity (Resistive Load)

<b>Power Level (silver):</b>	6A @ 125V AC or 3A @ 250V AC
<b>Logic Level (gold):</b>	0.4VA maximum @ 28V AC/DC maximum (Applicable Range 0.1mA ~ 0.1A @ 20mV ~ 28V)
<b>Logic/Power Level: (gold over silver)</b>	Combines silver & gold ratings

Note: Find additional explanation of dual rating & operating range in Supplement section.

## Other Ratings

<b>Contact Resistance:</b>	10 milliohms maximum for silver; 20 milliohms maximum for gold
<b>Insulation Resistance:</b>	1,000 megohms minimum @ 500V DC
<b>Dielectric Strength:</b>	1,000V AC minimum between contacts for 1 minute minimum; 1,500V AC minimum between contacts & case for 1 minute minimum
<b>Mechanical Life:</b>	100,000 operations minimum
<b>Electrical Life:</b>	25,000 operations minimum for silver; 50,000 operations minimum for gold
<b>Contact Timing:</b>	Nonshorting (break-before-make)
<b>Total Travel:</b>	On-None-On circuit .087" (2.2mm); all other circuits .138" (3.5mm)

## Materials & Finishes

<b>Actuator:</b>	Glass fiber reinforced PBT resin (UL94V-0)
<b>Frame:</b>	Stainless steel for panel & PCB mount; phosphor bronze with tin plating for bracket mount
<b>Dust Cover:</b>	Phosphor bronze with nickel plating
<b>Case:</b>	Glass fiber reinforced diallyl phthalate resin (UL94V-0)
<b>Movable Contacts:</b>	Silver alloy (code W); copper with gold plating (code G); or silver alloy with gold plating (code A)
<b>Stationary Contacts:</b>	Silver capped copper with silver plating (code W); copper with gold plating (code G); or silver alloy with gold plating (code A)
<b>Terminals:</b>	Copper or brass with silver or gold plating

## Environmental Data

<b>Operating Temp Range:</b>	-30°C through +85°C (-22°F through +185°F)
<b>Humidity:</b>	90 ~ 95% humidity for 96 hours @ 40°C (104°F)
<b>Vibration:</b>	10 ~ 55Hz with peak-to-peak amplitude of 1.5mm traversing the frequency range & returning in 1 minute; 3 right angled directions for 2 hours
<b>Shock:</b>	50G (490m/s <sup>2</sup> ) acceleration (tested in 6 right angled directions, with 5 shocks in each direction)

## Processing

<b>Soldering:</b>	Wave Soldering recommended (PC Mount). See Profile A in Supplement section. Manual Soldering: See Profile A in Supplement section.
<b>Cleaning:</b>	These devices are not process sealed. Hand clean locally using alcohol based solution.

## Standards & Certifications

<b>Flammability Standards:</b>	UL94V-0 rated actuator & case
<b>UL:</b>	File No. E44145 All Single & Double Pole Double Throw models recognized at 6A @ 125V AC & 3A @ 250V AC. Add "/U" to end of part number to order UL mark on switch. Add "/CUL" to end of part number to order cULus mark on switch.
<b>CSA:</b>	File No. 023535_0_000 All Double Throw & 3 Throw models certified at 6A @ 125V AC, 3A @ 250V AC, & 0.4VA maximum @ 28V DC. Add "/C" to end of part number to order CSA mark on switch.

# Distinctive Characteristics

Available in flat frame and bracketed PC mounting types.

Over-center actuator block and plunger design gives crisp actuation with clear indication of circuit status; this design also diminishes sparking and increases operating life.

Guide interlocked with actuator block prevents window locking and maintains correct plunger alignment to assure contact stability.

Antijamming design protects contacts from damage due to excessive downward force on the actuator.

High internal barriers between poles and insulating sheet between case and actuator block give added protection to contacts.

Specially composed silver alloy contacts for power applications or gold contacts for logic level applications give high contact reliability.

Prominent external insulating barriers increase insulation resistance and dielectric strength.

Epoxy sealed terminals prevent entry of flux, solvents, and other contaminants.

Clinching of frame to case well above base and terminals provides 1,500V dielectric strength.

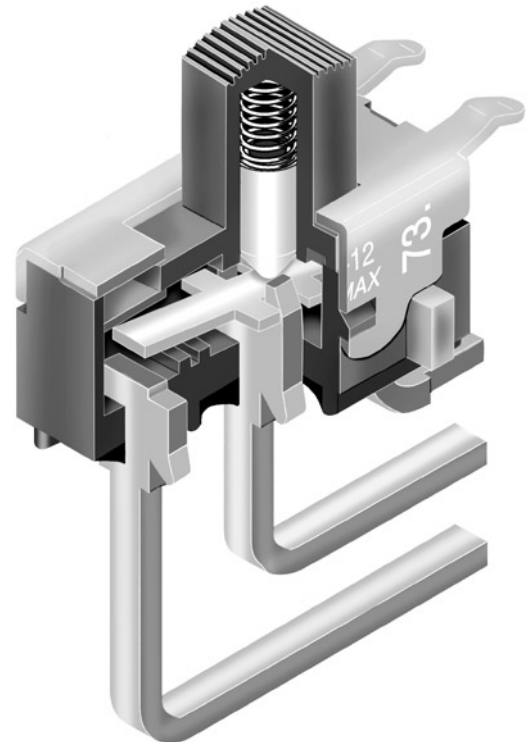

Actual Size

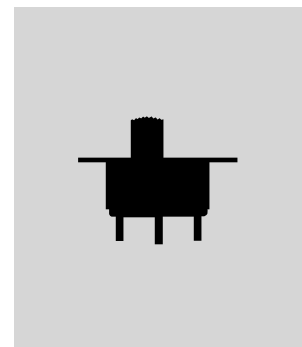

Toggles

Rockers

Pushbuttons

Illuminated PB

Programmable

Keylocks

Rotaries

**H** Slides

Tactiles

Tilt

Touch

Indicators

Accessories

Supplement

## TYPICAL SWITCH ORDERING EXAMPLE

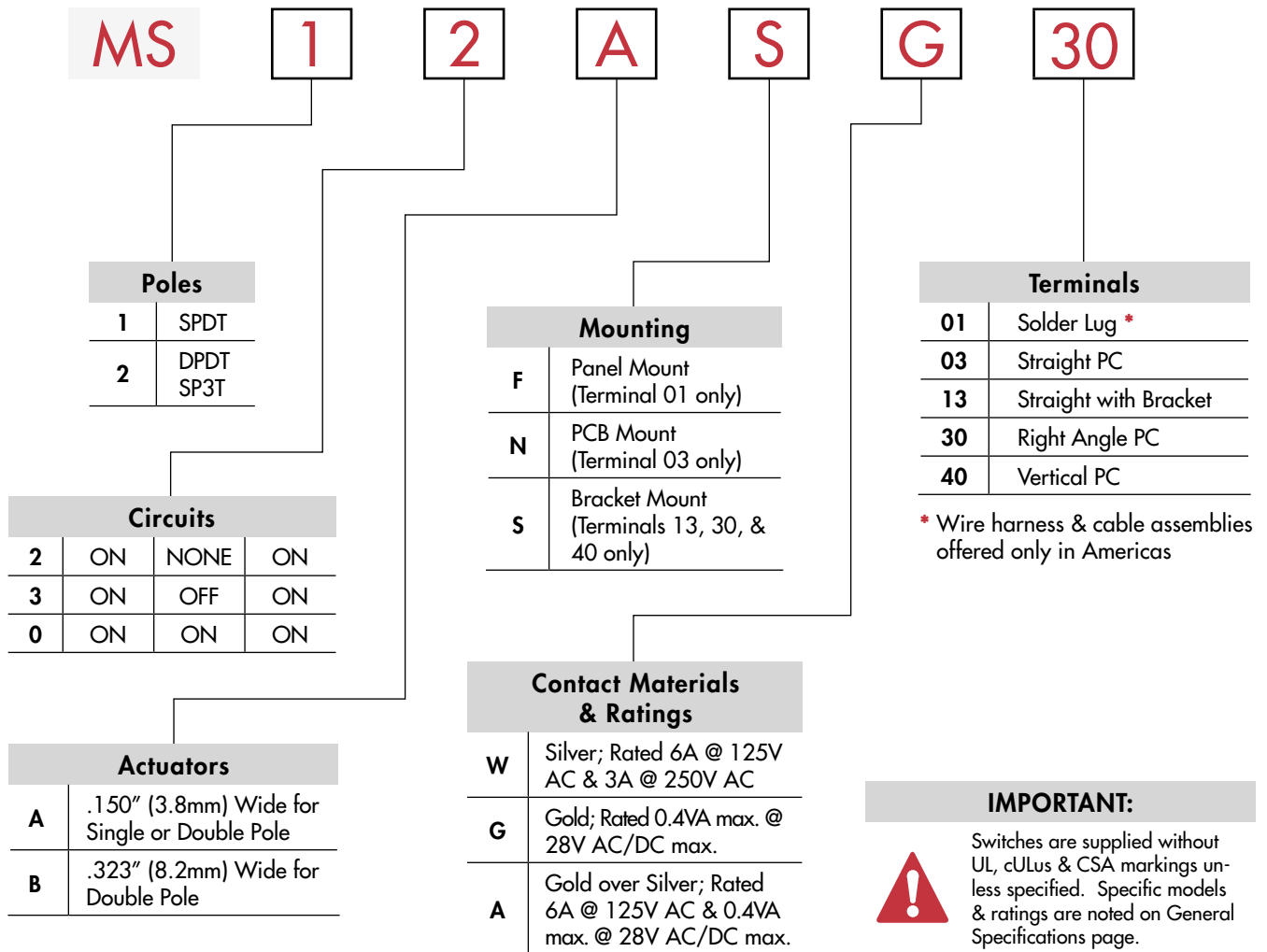

**IMPORTANT:**

 Switches are supplied without UL, cULus & CSA markings unless specified. Specific models & ratings are noted on General Specifications page.

## DESCRIPTION FOR TYPICAL ORDERING EXAMPLE

### MS12ASG30

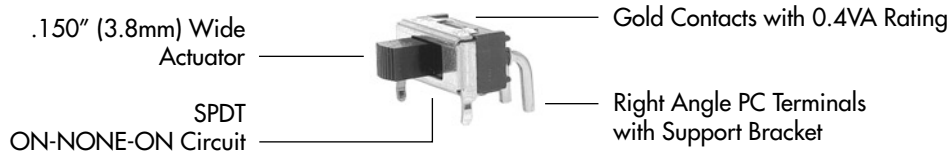

Toggles  
Rocker  
Pushbuttons  
Illuminated PB  
Programmable  
Keylocks  
Rotaries  
Slides H  
Tactiles  
Tilt  
Touch  
Indicators  
Accessories  
Supplement

## POLES & CIRCUITS

		Slide Position			Connected Terminals			Throw & Schematics
Pole	Model	Left	Center	Right	Left	Center	Right	
								Note: Terminal numbers are not actually on the switch.
SP	MS12 MS13	ON	NONE OFF	ON ON	2-1	OPEN	2-3	SPDT 
DP	MS22 MS23	ON	NONE OFF	ON ON	2-1 5-4	OPEN	2-3 5-6	DPDT 

### For 3 Throw (3-On)

Pole	Model	Connected Terminals & Schematics			External Connection
		Left	Center	Right	
SP	MS20	ON  2-1 5-4	ON  2-3 5-4	ON  2-3 5-6	<p>The SP3T model utilizes a double pole base.</p> <p>External connections must be made during field installation.</p>

## ACTUATORS

**A** .150" (3.8mm) Wide for Single Pole



.150" (3.8mm) Wide for Double Pole

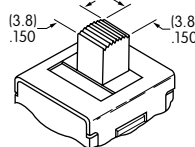

**B** .323" (8.2mm) Wide for Double Pole Only



## CONTACT MATERIALS & RATINGS

**W** Silver over Silver      Power Level      6A @ 125V AC & 3A @ 250V AC

**G** Gold over Brass or Copper      Logic Level      0.4VA maximum @ 28V AC/DC maximum  
Note: Complete explanation of operating range in Supplement section.

**A** Gold over Silver      Power Level or Logic Level      6A @ 125V AC or 0.4VA maximum @ 28V AC/DC maximum

Note: This dual rated option is suitable when two or more identical switches are used in logic and in power circuits within the same application. See Supplement section for complete explanation of dual rating and operating range.

## MOUNTING TYPES & TERMINALS

**F** Panel Mount  
(Combines with Solder  
Lug Terminal 01 only)

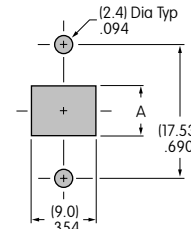
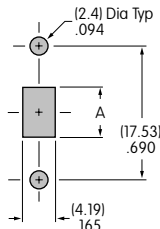

**N** Straight PC Mount  
(Combines with  
Straight PC Terminal  
03 only)



Dimension A =  
.268" (6.8mm) for on-none-on  
.319" (8.1mm) for on-off-on & on-on-on

Maximum Panel Thickness: .197" (5.0mm)

SP or DP with .150"  
(3.8mm) Actuator

DP only with .323"  
(8.2mm) Actuator

**S** Support Bracket Mount  
(For Terminals 13, 30, & 40)



Maximum Panel Thickness:  
For Straight PC with Bracket Terminal 13: .197" (5.0mm)  
For Angle Mount Terminals 30 & 40: .177" (4.5mm)

**01** Solder Lug



**03** Straight PC



**13** Straight PC with Bracket

**30** Right Angle PC

**40** Vertical PC

## TYPICAL SWITCH DIMENSIONS

Solder Lug Terminals



MS12AFW01

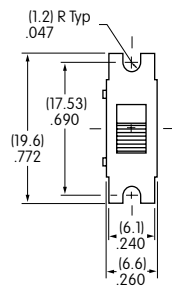

Single Pole



Actuator in LEFT Position

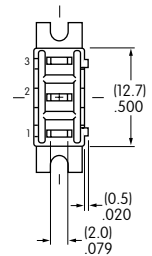

Solder Lug Terminals



MS22BFW01



Double Pole

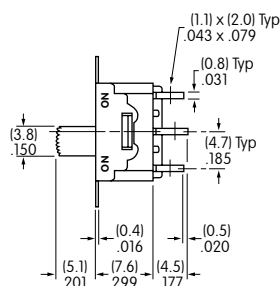

Actuator in LEFT Position



Toggles  
Rockers  
Pushbuttons  
Illuminated PB  
Keylocks  
Rotaries  
Slides  
Tactiles  
Tilt  
Touch  
Indicators  
Accessories  
Supplement

TYPICAL SWITCH DIMENSIONS

Single Pole

Straight PC Terminals

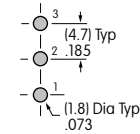
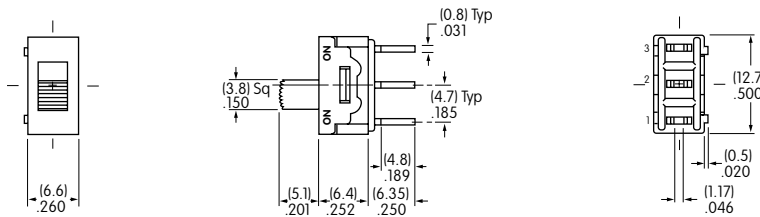

Actuator in LEFT Position

MS12ANG03

Double Pole

Straight PC Terminals

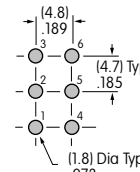
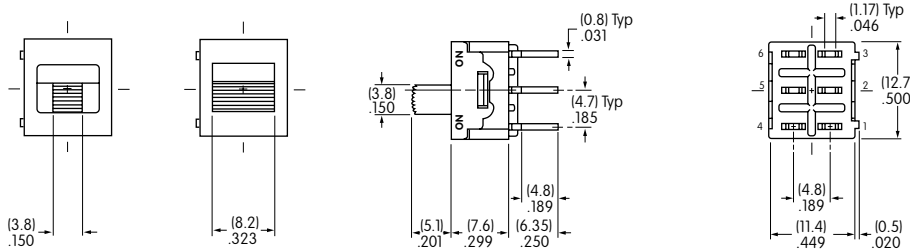

Actuator in LEFT Position

MS22BNG03

Single Pole

Straight PC Terminals with Bracket

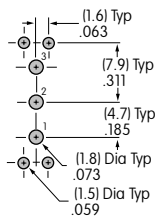
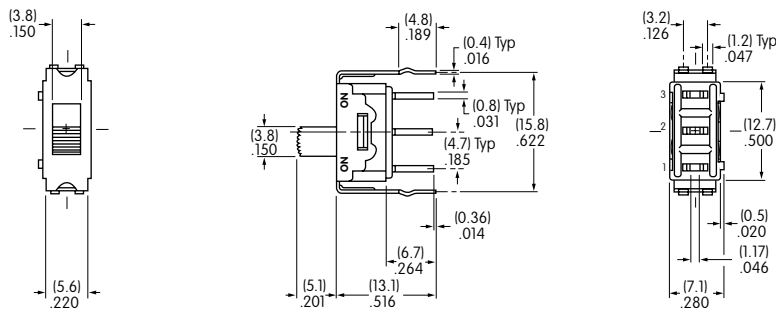

Actuator in LEFT Position

MS12ASG13

Double Pole

Straight PC Terminals with Bracket

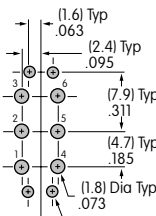
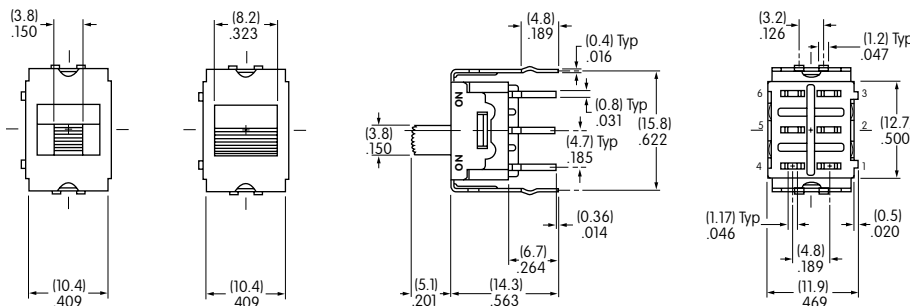

Actuator in LEFT Position

MS22BSG13

## TYPICAL SWITCH DIMENSIONS

### Right Angle PC Terminals

### Single Pole

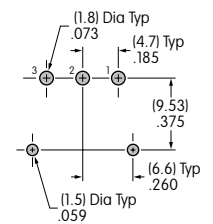
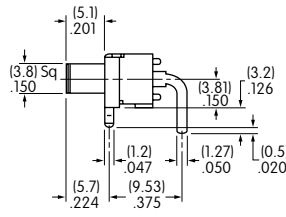
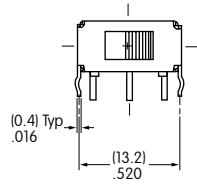

**MS12ASG30**

Actuator in LEFT Position

### Right Angle PC Terminals

### Double Pole

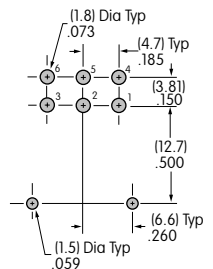
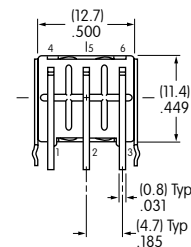
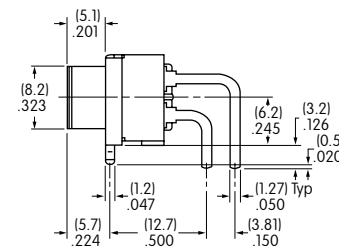
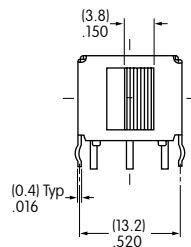
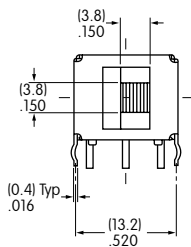

**MS22BSG30**

Actuator in LEFT Position

### Vertical PC Terminals

### Single Pole

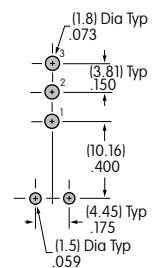
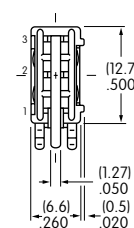
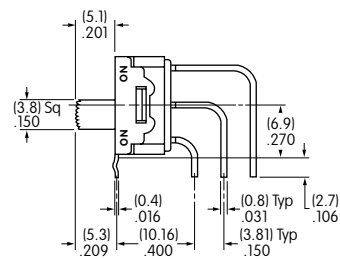
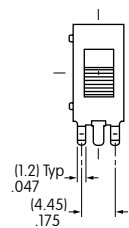

**MS12ASG40**

Actuator in LEFT Position

### Vertical PC Terminals

### Double Pole

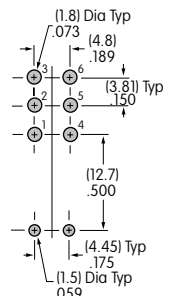
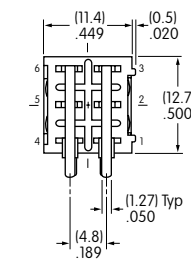
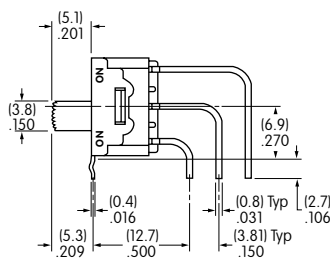
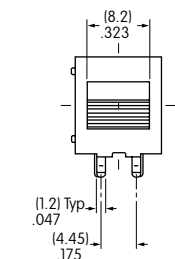
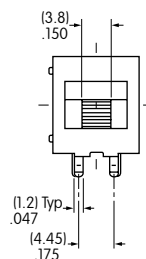

**MS22BSG40**

Actuator in LEFT Position