

## Type 12 Mild Steel Miniature Pushbutton Enclosures



### Application

- Designed to accept 22mm miniature oil tight pushbuttons, switches and pilot lights.
- Provides protection from dirt, dust, oil and water.

### Standards

- UL 508 Type 12 and 13
- CSA Type 12 and 13
- **Complies with**
  - NEMA Type 12 and 13
  - JIC EMP-1-1967
  - JIC EGP-1-1967
  - IEC 60529, IP54
- Appropriate components are required to maintain these standards.

### Construction

- Formed 14 gauge steel except the MPB1 which is 16 gauge.
- Smooth continuously welded seams.
- Welded brackets provide for enclosure mounting.
- Captive cover screws thread into sealed wells.
- Larger enclosures provide internally hinged removable covers, designed to hold the cover open during wiring (see table).
- Oil resistant gasket and adhesive.
- A bonding stud is provided on the door and a grounding stud is provided on the enclosure.

### Finish

- Cover and enclosure are phosphatized and finished in ANSI 61 gray powder coating.

### Accessories

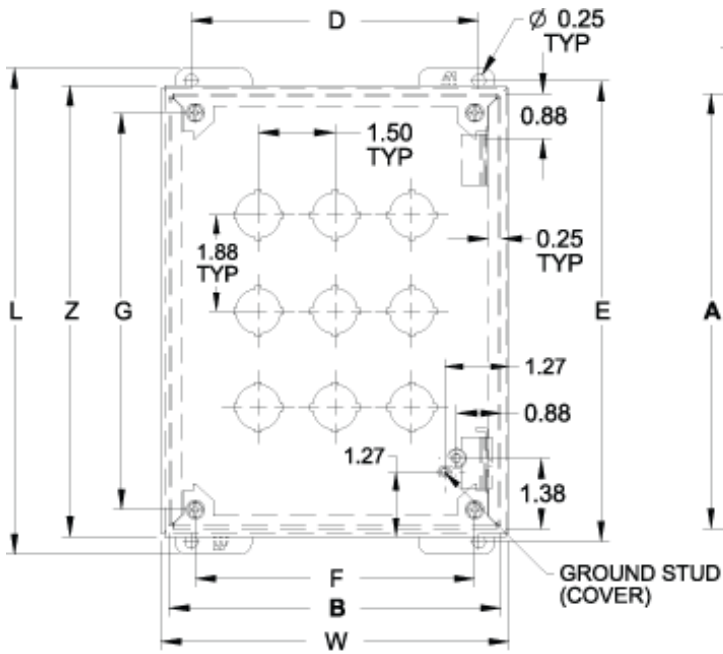

**Front View**  
Body Type MPB6 through MPB12  
(Hinged)

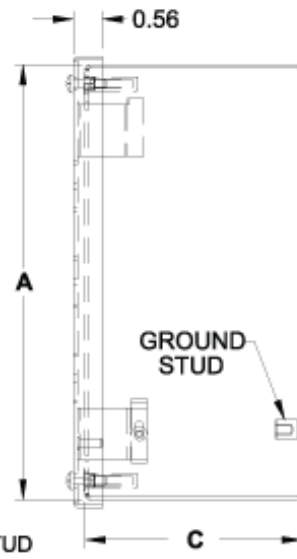

**Side View**

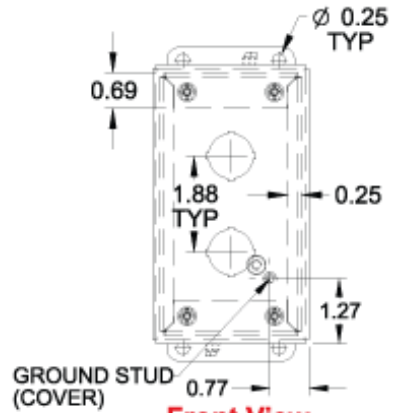

**Front View**  
Body Type MPB1 through MPB4  
(Not Hinged)

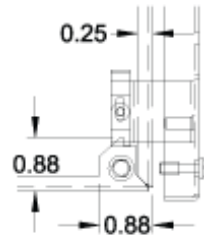

**Hinge Detail**  
Retractable pin allows door to be  
mounted on left or right side

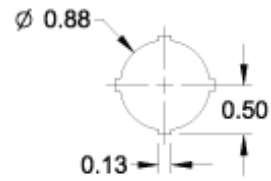

**22.5mm Detail**

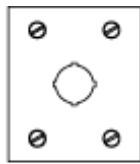

**MPB1**

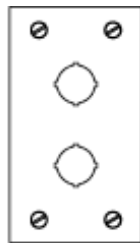

**MPB2**

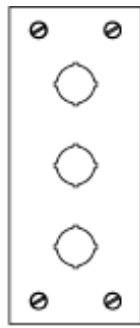

**MPB3**

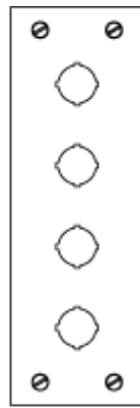

**MPB4**

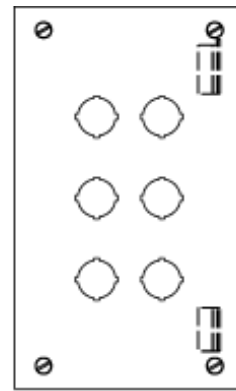

**MPB6**

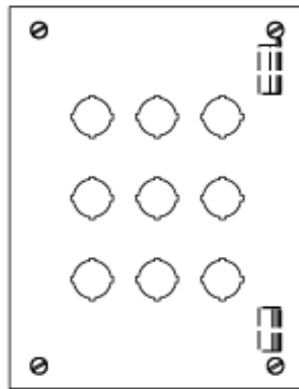

**MPB9**

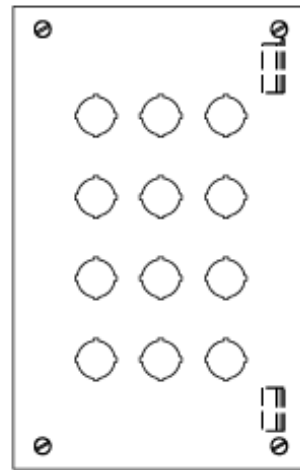

**MPB12**

Part No.	No. of Holes	Overall Dimensions							Overall Dimensions			Ship Wt. (lbs)
		A	B	C	D	E	F	G	L	W	Z	
MPB1 <sup>1</sup>	1	3.25	2.75	3.50	1.88	3.75	1.71	2.50	4.25	3.06	3.56	2
MPB2 <sup>1</sup>	2	5.13	2.75	3.50	1.88	5.63	1.71	4.38	6.13	3.06	5.44	3
MPB3 <sup>1</sup>	3	7.00	2.75	3.50	1.88	7.50	1.71	6.25	8.00	3.06	7.31	3
MPB4 <sup>1</sup>	4	8.88	2.75	3.50	1.88	9.38	1.71	8.13	9.88	3.06	9.19	4
MPB6	6	8.50	5.00	4.25	4.13	9.00	3.96	7.75	9.50	5.31	8.81	5
MPB9	9	8.50	6.50	4.25	5.63	9.00	5.46	7.75	9.50	6.81	8.81	6
MPB12	12	10.38	6.50	4.25	5.63	10.88	5.46	9.63	11.38	6.81	10.69	6

<sup>1</sup> Not hinged

Data subject to change without notice

© 2014. Hammond Manufacturing Ltd. All rights reserved.