

EAO – Your Expert Partner for Human Machine Interfaces



EAO Product Information

Series 03

Description	3
Product Assembly	4
Devices raised mounting	5
Accessories.....	15
Technical Data.....	23
Typical Applications	25
Application guidelines.....	26
Marking	27
Drawings.....	28
Index.....	34

Product Information

General notes

The pushbuttons of series 03 are noteworthy for the robust design of their case, their operational reliability and the large marking and illuminated area. The pushbuttons contain one or two separately operating snap-action switching elements.

The illuminated pushbuttons 03, with two independent lamps, permit different modes of indication.

- Indication of two different functions.
- Indication in two colours of two different functions.
- Enhanced reliability of indication with two lamps.

Furthermore, Series 03 can be equipped with two switching systems operating independently or mechanically interlocked.

Switches with free choice of bezel

The free choice of bezel enables users to match switches to suit different purposes. These bezels protect against unintentional switching. Standard bezels can be obtained in black.

Mounting

The switches, which are pushed into the opening in the panel from the front, are fixed with a plastic sleeve with a maximum effort of 20 Ncm.

Lenses

The flat lenses, made of polymethyl methacrylate, are obtainable in various colours, as well as transparent and translucent. For Series 03 we can supply lenses in two colours or for separately operated switching mechanisms (2 lenses per switch). Also a number of special lenses are available with special illumination facilities, e.g. for dark rooms. All lenses can be exchanged without affecting the switch position.

Marking

For further information about engraving, hot stamping and film inserts see part Marking.

Illumination

The T6.8 incandescent (filament) lamp (6...48 V, 1.2 W) ensures perfect illumination of the lenses, which are supplied in various colours.

T6.8 Single-LED (6, 12, 24, 28, 48 V) are also available in blue, green, red, white or yellow.

Luminosity and wave length scattering caused by the technology used in the LED manufacturing processes may lead to visual differences in our products.

For supply voltages above 48 V, it is necessary to use a voltage reduction element (external series resistor or transformer).

Keylock switch

Standard lock number is YB1. If the lock number is not specified, we will supply standard number YB1.

Additional 9 lock numbers are available on request.

Two keys are supplied with each keylock switch.

Spare keys for standard locks may be ordered by quoting Typ-Nr. 02-989.

Number structure

Nomenclature in accordance with ' IEC 61058 TEST REPORT '. The certification document we dispatch to them on demands.

Specimen order

Illuminated pushbutton :

- | | |
|--|------------|
| - 1x Illuminated pushbutton actuator,
24 x 48 mm, 2 change over contacts,
momentary action, screw terminal | 03-624.011 |
|--|------------|

Essential accessories :

- | | |
|--|--------------|
| - 2x Lens halved plastic colourless, transparent | 03-943.7 |
| - 2x Holder halved, farblos | 03-922.7 |
| - 2x Diffusor plate halved | 03-926 |
| - 1x Front bezel flush, black | 03-965.0 |
| - 2x Single-LED, T6.8, 24 VAC/DC, white diffuse | 10-2K12.1079 |

*We reserve the right to modify technical data
All dimensions in mm*

Pushbutton illuminated, raised mounting

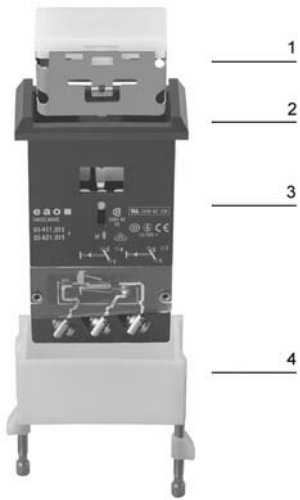





- 1 Lens
- 2 Front bezel
- 3 Switch housing
- 4 Fixing bezel

Indicator actuator



Essential Accessories:

-  Diffuser plate one-part page 19
-  Front bezel flush page 19
-  Holder one-part page 18
-  Lens one-part, uni-colour for Pushbutton and Illuminated pushbutton one-part page 16
-  Single-LED page 21

	Front protection	Terminals	□ 24 x 48 mm Typ-Nr.	Mounting dimensions	Technical drawing	Circuit drawing	
Indicator actuator two independent lamp bases	IP 40	PT 2.8	03-021.002	1	1	2	0.045
		PT 4.8	03-021.003	1	1	2	0.045
		ST	03-021.001	1	1	2	0.045

Terminals: PT 2.8 = Plug-in terminal 2.8 mm, PT 4.8 = Plug-in terminal 4.8 mm, ST = Screw terminal
 Mounting dimensions from page 28, Technical drawing from page 28, Circuit drawing from page 31

Buzzer actuator



Essential Accessories:

-  Front bezel raised page 19

	Front protection	Front cap	Terminals	□ 24 x 48 mm Typ-Nr.	Mounting dimensions	Technical drawing	Circuit drawing	
Buzzer actuator Operation voltage : 10 ... 50 VAC, 10 ... 75 VDC	IP 40	Plastic black	ST	03-810.001	1	2	1	0.060

Further information in the Technical Data and Typical Applications



Terminals: ST = Screw terminal

Mounting dimensions from page 28, Technical drawing from page 28, Circuit drawing from page 31

Pushbutton actuator one-part



Essential Accessories:

-  Front bezel flush page 19
-  Lens one-part, uni-colour for Pushbutton and Illuminated pushbutton one-part page 16

	Front protection	Switching system	Contacts	Switching action	Terminals	□ 24 x 48 mm Typ-Nr.	Mounting dimensions	Technical drawing	Circuit drawing	
Pushbutton actuator one-part	IP 40	SA	1 C	MA	PT 2.8	03-613.012	1	5	7	0.055
					PT 4.8	03-613.013	1	5	7	0.055
					ST	03-613.011	1	5	7	0.055
				M	PT 2.8	03-611.012	1	5	8	0.055
					PT 4.8	03-611.013	1	5	8	0.055
					ST	03-611.011	1	5	8	0.055
			2 C	MA	PT 2.8	03-614.012	1	5	3	0.065
					PT 4.8	03-614.013	1	5	3	0.065
					ST	03-614.011	1	5	3	0.065
				M	PT 2.8	03-612.012	1	5	9	0.065
					PT 4.8	03-612.013	1	5	9	0.065
					ST	03-612.011	1	5	9	0.065
				M-MA	PT 2.8	03-615.012	1	5	6	0.065
					PT 4.8	03-615.013	1	5	6	0.065
					ST	03-615.011	1	5	6	0.065

Switching system: SA = Snap-action switching element

Contacts: C = Changeover

Switching action: MA = Maintained action, M = Momentary action, M-MA = Momentary action-Maintained action



Terminals: PT 2.8 = Plug-in terminal 2.8 mm, PT 4.8 = Plug-in terminal 4.8 mm, ST = Screw terminal

Mounting dimensions from page 28, Technical drawing from page 28, Circuit drawing from page 31

Pushbutton actuator two-part



Essential Accessories:

-  Front bezel flush page 19
-  Lens halved for Pushbutton two-part page 15

	Front protection	Switching system	Contacts	Switching action	Terminals	□ 24 x 48 mm Typ-Nr.	Mounting dimensions	Technical drawing	Circuit drawing	
Pushbutton actuator two-part independent changeover	IP 40	SA	2 C	MA	PT 2.8	03-622.012	1	5	10	0.065
					PT 4.8	03-622.013	1	5	10	0.065
					ST	03-622.011	1	5	10	0.065
				M	PT 2.8	03-621.012	1	5	12	0.065
					PT 4.8	03-621.013	1	5	12	0.065
					ST	03-621.011	1	5	12	0.065
				M-MA	PT 2.8	03-623.012	1	5	11	0.065
					PT 4.8	03-623.013	1	5	11	0.065
					ST	03-623.011	1	5	11	0.065

Switching system: SA = Snap-action switching element

Contacts: C = Changeover

Switching action: MA = Maintained action, M = Momentary action, M-MA = Momentary action-Maintained action



Terminals: PT 2.8 = Plug-in terminal 2.8 mm, PT 4.8 = Plug-in terminal 4.8 mm, ST = Screw terminal

Mounting dimensions from page 28, Technical drawing from page 28, Circuit drawing from page 31

Pushbutton actuator locked mechanically



Essential Accessories:

-  Front bezel flush page 19
-  Lens halved for Pushbutton and Illuminated pushbutton locked mechanically page 15

	Front protection	Switching system	Contacts	Switching action	Terminals	□ 24 x 48 mm Typ-Nr.	Mounting dimensions	Technical drawing	Circuit drawing	
Pushbutton actuator locked mechanically	IP 40	SA	2 C	MA	PT 2.8	03-629.012	1	9	10	0.075
					PT 4.8	03-629.013	1	9	10	0.075
					ST	03-629.011	1	9	10	0.075

Switching system: SA = Snap-action switching element

Contacts: C = Changeover

Switching action: MA = Maintained action





Terminals: PT 2.8 = Plug-in terminal 2.8 mm, PT 4.8 = Plug-in terminal 4.8 mm, ST = Screw terminal

Mounting dimensions from page 28, Technical drawing from page 28, Circuit drawing from page 31

Illuminated pushbutton actuator one-part



Essential Accessories:

-  Diffuser plate one-part page 19
-  Front bezel flush page 19
-  Holder one-part page 18
-  Lens one-part, uni-colour for Pushbutton and Illuminated pushbutton one-part page 16
-  Single-LED page 21

	Front protection	Switching system	Contacts	Switching action	Terminals	□ 24 x 48 mm Typ-Nr.	Mounting dimensions	Technical drawing	Circuit drawing	
Illuminated pushbutton actuator one-part two independent lamp bases	IP 40	SA	1 C	MA	PT 2.8	03-618.012	1	5	5	0.070
					PT 4.8	03-618.013	1	5	5	0.070
					ST	03-618.011	1	5	5	0.070
				M	PT 2.8	03-616.012	1	5	13	0.070
					PT 4.8	03-616.013	1	5	13	0.070
					ST	03-616.011	1	5	13	0.070
			2 C	MA	PT 2.8	03-619.012	1	5	4	0.075
					PT 4.8	03-619.013	1	5	4	0.075
					ST	03-619.011	1	5	4	0.075
				M	PT 2.8	03-617.012	1	5	15	0.075
					PT 4.8	03-617.013	1	5	15	0.075
					ST	03-617.011	1	5	15	0.075
				M-MA	PT 2.8	03-620.012	1	5	14	0.075
					PT 4.8	03-620.013	1	5	14	0.075
					ST	03-620.011	1	5	14	0.075

Switching system: SA = Snap-action switching element

Contacts: C = Changeover

Switching action: MA = Maintained action, M = Momentary action, M-MA = Momentary action-Maintained action





Terminals: PT 2.8 = Plug-in terminal 2.8 mm, PT 4.8 = Plug-in terminal 4.8 mm, ST = Screw terminal

Mounting dimensions from page 28, Technical drawing from page 28, Circuit drawing from page 31

Illuminated pushbutton actuator two-part



Essential Accessories:

-  Diffuser plate halved page 18
-  Front bezel flush page 19
-  Holder halved page 18
-  Lens halved for Pushbutton two-part page 15
-  Single-LED page 21

	Front protection	Switching system	Contacts	Switching action	Terminals	□ 24 x 48 mm Typ-Nr.	Mounting dimensions	Technical drawing	Circuit drawing	
Illuminated pushbutton actuator two-part two independent lamp bases	IP 40	SA	1 C	MA	PT 2.8	03-628.012	1	5	5	0.075
					PT 4.8	03-628.013	1	5	5	0.075
					ST	03-628.011	1	5	5	0.075
				M	PT 2.8	03-627.012	1	5	13	0.075
					PT 4.8	03-627.013	1	5	13	0.075
					ST	03-627.011	1	5	13	0.075
two independent lamp bases independent changeover	IP 40	SA	2 C	MA	PT 2.8	03-625.012	1	5	16	0.080
					PT 4.8	03-625.013	1	5	16	0.080
					ST	03-625.011	1	5	16	0.080
				M	PT 2.8	03-624.012	1	5	18	0.080
					PT 4.8	03-624.013	1	5	18	0.080
					ST	03-624.011	1	5	18	0.080
				M-MA	PT 2.8	03-626.012	1	5	17	0.080
					PT 4.8	03-626.013	1	5	17	0.080
					ST	03-626.011	1	5	17	0.080

Switching system: SA = Snap-action switching element

Contacts: C = Changeover

Switching action: MA = Maintained action, M = Momentary action, M-MA = Momentary action-Maintained action





Terminals: PT 2.8 = Plug-in terminal 2.8 mm, PT 4.8 = Plug-in terminal 4.8 mm, ST = Screw terminal

Mounting dimensions from page 28, Technical drawing from page 28, Circuit drawing from page 31

Illuminated pushbutton actuator locked mechanically



Essential Accessories:

-  Diffuser plate halved page 18
-  Front bezel flush page 19
-  Holder halved page 18
-  Lens halved for Pushbutton and Illuminated pushbutton locked mechanically page 15
-  Single-LED page 21

	Front protection	Switching system	Contacts	Switching action	Terminals	□ 24 x 48 mm Typ-Nr.	Mounting dimensions	Technical drawing	Circuit drawing	
Illuminated pushbutton actuator locked mechanically two independent lamp bases	IP 40	SA	2 C	MA	PT 2.8	03-631.012	1 9 16	0.090		
					PT 4.8	03-631.013	1 9 16	0.090		
					ST	03-631.011	1 9 16	0.090		
				M	PT 2.8	03-630.012	1 9 18	0.090		
					PT 4.8	03-630.013	1 9 18	0.090		
					ST	03-630.011	1 9 18	0.090		
				M-MA	PT 2.8	03-632.012	1 9 17	0.090		
					PT 4.8	03-632.013	1 9 17	0.090		
					ST	03-632.011	1 9 17	0.090		

Switching system: SA = Snap-action switching element

Contacts: C = Changeover

Switching action: MA = Maintained action, M = Momentary action, M-MA = Momentary action-Maintained action



Terminals: PT 2.8 = Plug-in terminal 2.8 mm, PT 4.8 = Plug-in terminal 4.8 mm, ST = Screw terminal

Mounting dimensions from page 28, Technical drawing from page 28, Circuit drawing from page 31

Mushroom-pushbutton actuator



Essential Accessories:

-  Front bezel flush page 19
-  Mushroom-head cap page 18

	Front protection	Switching system	Contacts	Switching action	Terminals	□ 24 x 48 mm Typ-Nr.	Mounting dimensions	Technical drawing	Circuit drawing	
Mushroom-pushbutton actuator	IP 40	SA	1 C	MA	PT 2.8	03-613.012	1	8	5	0.055
					PT 4.8	03-613.013	1	8	5	0.055
					ST	03-613.011	1	8	5	0.055
				M	PT 2.8	03-611.012	1	8	13	0.055
					PT 4.8	03-611.013	1	8	13	0.055
					ST	03-611.011	1	8	13	0.055
			2 C	MA	PT 2.8	03-614.012	1	8	4	0.065
					PT 4.8	03-614.013	1	8	4	0.065
					ST	03-614.011	1	8	4	0.065
				M	PT 2.8	03-612.012	1	8	15	0.065
					PT 4.8	03-612.013	1	8	15	0.065
					ST	03-612.011	1	8	15	0.065
				M-MA	PT 2.8	03-615.012	1	8	14	0.065
					PT 4.8	03-615.013	1	8	14	0.065
					ST	03-615.011	1	8	14	0.065

Switching system: SA = Snap-action switching element

Contacts: C = Changeover

Switching action: MA = Maintained action, M = Momentary action, M-MA = Momentary action-Maintained action

Terminals: PT 2.8 = Plug-in terminal 2.8 mm, PT 4.8 = Plug-in terminal 4.8 mm, ST = Screw terminal

Mounting dimensions from page 28, Technical drawing from page 28, Circuit drawing from page 31

Keylock switch actuator 2 positions

Note:

The keylock front bezel of the switch types 03-198.01x and 03-695.01x are factory-assembled and do not have to be ordered separately.



Essential Accessories:

 Keylock front bezel page 18

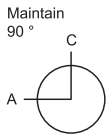

	Front protection	Switching action	Switching system	Contacts	Key remove	Terminals	□ 24 x 48 mm Typ-Nr.	Mounting dimensions	Technical drawing	Circuit drawing	
Keylock switch actuator 2 positions Position A : lockable, actuated or non-actuated Standard lock YB1 Front plastic grey	IP 40	M-MA	SA	2 C	A	PT 2.8	03-692.012	1	6	19	0.065
						PT 4.8	03-692.013	1	6	19	0.065
						ST	03-692.011	1	6	19	0.065
Position A : lockable, actuated Standard lock YB1 Front plastic grey	IP 40	M-MA	SA	2 C	A	PT 2.8	03-690.012	1	6	19	0.065
						PT 4.8	03-690.013	1	6	19	0.065
						ST	03-690.011	1	6	19	0.065
Position A : lockable, non-actuated Standard lock YB1 Front plastic grey	IP 40	M-MA	SA	2 C	A	PT 2.8	03-691.012	1	6	19	0.065
						PT 4.8	03-691.013	1	6	19	0.065
						ST	03-691.011	1	6	19	0.065
Position A : lockable, actuated or non-actuated Standard lock YB1 Front plastic grey (usable with Protective cover Typ-Nr. 03-925)	IP 40	M-MA	SA	2 C	A	PT 2.8	03-198.012	1	6	19	0.065
						PT 4.8	03-198.013	1	6	19	0.065
						ST	03-198.011	1	6	19	0.065
Position A : lockable, non-actuated Position C : actuated, key not removeable Standard lock YB1 Front plastic grey	IP 40	M-MA	SA	2 C	A	PT 2.8	03-695.012	1	6	19	0.065
						PT 4.8	03-695.013	1	6	19	0.065
						ST	03-695.011	1	6	19	0.065

After turning the key 90° clockwise, the switch can be operated.

In the unlocked positions the switch always performs a momentary action.

Other lock numbers on request

Switching action: M-MA = Momentary action-Maintained action

Switching system: SA = Snap-action switching element

Contacts: C = Changeover

Terminals: PT 2.8 = Plug-in terminal 2.8 mm, PT 4.8 = Plug-in terminal 4.8 mm, ST = Screw terminal

Mounting dimensions from page 28, Technical drawing from page 28, Circuit drawing from page 31

Mushroom-head keylock switch actuator 2 positions

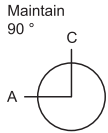

	Front protection	Switching action	Switching system	Contacts	Terminals	Key remove	□ 24 x 48 mm Typ-Nr.	Mounting dimensions	Technical drawing	Circuit drawing	
Mushroom-head keylock switch actuator 2 positions Position A : lockable, actuated Standard lock YB1 Mushroom-head cap plastic red	IP 40	M-MA	SA	2 C	PT 2.8	A	03-199.012	1	7	19	0.065
					PT 4.8	A	03-199.013	1	7	19	0.065
					ST	A	03-199.011	1	7	19	0.065

Switching action: M-MA = Momentary action-Maintained action

Switching system: SA = Snap-action switching element

Contacts: C = Changeover

Terminals: PT 2.8 = Plug-in terminal 2.8 mm, PT 4.8 = Plug-in terminal 4.8 mm, ST = Screw terminal

Mounting dimensions from page 28, Technical drawing from page 28, Circuit drawing from page 31

Front

Lens halved for Pushbutton two-part

Order 2 lenses

	Lens	□ 24 x 48 mm Typ-Nr.	
Lens halved for Pushbutton two-part 18 x 19 mm, illuminative (not recommended for film insert), ribbed	Plastic blue translucent	03-921.6	0.005
	Plastic colourless translucent	03-921.7	0.005
	Plastic green translucent	03-921.5	0.005
	Plastic orange translucent	03-921.3	0.005
	Plastic red translucent	03-921.2	0.005
	Plastic smoked translucent	03-921.1	0.005
	Plastic white translucent	03-921.9	0.005
	Plastic yellow translucent	03-921.4	0.005
18 x 19 mm, illuminative (use Holder for film insert)	Plastic colourless transparent	03-943.7	0.005
18 x 19 mm, non-illuminative	Plastic black opaque	03-921.0	0.005
	Plastic grey opaque	03-921.8	0.005
18 x 38 mm, illuminative with black rim (prevents lateral light escape), (use Holder for film insert)	Plastic colourless transparent	03-953.7	0.005
	Plastic smoked transparent	03-954.1	0.005



Lens halved for Pushbutton and Illuminated pushbutton locked mechanically

Order 2 lenses

	Lens	□ 24 x 48 mm Typ-Nr.	
Lens halved for Pushbutton and Illuminated pushbutton locked mechanically 18 x 19 mm, illuminative (not recommended for film insert), ribbed	Plastic blue translucent	03-923.6	0.003
	Plastic colourless transparent	03-923.7	0.003
	Plastic green translucent	03-923.5	0.003
	Plastic orange translucent	03-923.3	0.003
	Plastic red translucent	03-923.2	0.003
	Plastic white translucent	03-923.9	0.003
	Plastic yellow translucent	03-923.4	0.003
	18 x 19 mm, non-illuminative	Plastic black opaque	03-923.0
Plastic grey opaque		03-923.8	0.003



Lens one-part, uni-colour for Pushbutton and Illuminated pushbutton one-part

	Lens	⌀ 24 x 48 mm Typ-Nr.	 kg
Lens one-part, uni-colour for Pushbutton and Illuminated pushbutton one-part 18 x 38 mm, illuminative (use Holder for film insert)	Plastic colourless transparent	03-941.7	0.009
18 x 38 mm, illuminative (not recommended for film insert), ribbed	Plastic blue translucent	03-901.6	0.009
	Plastic colourless translucent	03-901.7	0.009
	Plastic green translucent	03-901.5	0.009
	Plastic orange translucent	03-901.3	0.009
	Plastic red translucent	03-901.2	0.009
	Plastic smoked translucent	03-901.1	0.009
18 x 38 mm, illuminative with black rim (prevents lateral light escape), (use Holder for film insert)	Plastic colourless transparent	03-946.7	0.009
	Plastic smoked transparent	03-947.1	0.009
18 x 38 mm, non-illuminative	Plastic black opaque	03-901.0	0.009
	Plastic grey opaque	03-901.8	0.009
	Plastic white translucent	03-901.9	0.009



Lens one-part, bi-colour for Pushbutton and Illuminated pushbutton one-part

	Lens	□ 24 x 48 mm Typ-Nr.	
Lens one-part, bi-colour for Pushbutton and Illuminated pushbutton one-part 18 x 38 mm, illuminative with black rim (prevents lateral light escape), (use Holder for film insert)	Plastic colourless-colourless transparent	03-951.7/7	0.010
	Plastic smoked-smoked transparent	03-952.1/1	0.010
18 x 38 mm, illuminative with light barrier (not recommended for film insert), ribbed	Plastic black-blue opaque-translucent	03-902.0/6	0.010
	Plastic black-colourless opaque-translucent	03-902.0/7	0.010
	Plastic black-green opaque-translucent	03-902.0/5	0.010
	Plastic black-orange opaque-translucent	03-902.0/3	0.010
	Plastic black-red opaque-translucent	03-902.0/2	0.010
	Plastic black-yellow opaque-translucent	03-902.0/4	0.010
	Plastic blue-blue translucent	03-902.6/6	0.010
	Plastic blue-colourless translucent	03-902.6/7	0.010
	Plastic blue-white translucent	03-902.6/9	0.010
	Plastic colourless-colourless translucent	03-902.7/7	0.010
	Plastic colourless-white translucent	03-902.7/9	0.010
	Plastic green-blue translucent	03-902.5/6	0.010
	Plastic green-colourless translucent	03-902.5/7	0.010
	Plastic green-green translucent	03-902.5/5	0.010
	Plastic green-white translucent	03-902.5/9	0.010
	Plastic grey-blue opaque-translucent	03-902.6/8	0.010
	Plastic grey-colourless opaque-translucent	03-902.7/8	0.010
	Plastic grey-green opaque-translucent	03-902.5/8	0.010
	Plastic grey-orange opaque-translucent	03-902.3/8	0.010
	Plastic grey-red opaque-translucent	03-902.2/8	0.010
	Plastic grey-yellow opaque-translucent	03-902.4/8	0.010
	Plastic orange-blue translucent	03-902.3/6	0.010
	Plastic orange-colourless translucent	03-902.3/7	0.010
	Plastic orange-green translucent	03-902.3/5	0.010
	Plastic orange-orange translucent	03-902.3/3	0.010
	Plastic orange-white translucent	03-902.3/9	0.010
	Plastic orange-yellow translucent	03-902.3/4	0.010
	Plastic red-blue translucent	03-902.2/6	0.010
	Plastic red-colourless translucent	03-902.2/7	0.010
	Plastic red-green translucent	03-902.2/5	0.010
	Plastic red-orange translucent	03-902.2/3	0.010
	Plastic red-red translucent	03-902.2/2	0.010
	Plastic red-white translucent	03-902.2/9	0.010
	Plastic red-yellow translucent	03-902.2/4	0.010
Plastic smoked-smoked translucent	03-902.1/1	0.010	
Plastic yellow-blue translucent	03-902.4/6	0.010	
Plastic yellow-colourless translucent	03-902.4/7	0.010	
Plastic yellow-green translucent	03-902.4/5	0.010	
Plastic yellow-weiss translucent	03-902.4/9	0.010	
Plastic yellow-yellow translucent	03-902.4/4	0.010	
18 x 38 mm, illuminative with light barrier (use Holder for film insert)	Plastic colourless-colourless transparent	03-942.7/7	0.010
18 x 38 mm, non-illuminative ribbed	Plastic black-black opaque	03-902.0/0	0.010
	Plastic black-grey opaque	03-902.0/8	0.010
	Plastic black-white opaque-translucent	03-902.0/9	0.010
	Plastic grey-grey opaque	03-902.8/8	0.010
	Plastic grey-white opaque-translucent	03-902.8/9	0.010
	Plastic white-white translucent	03-902.9/9	0.010



Mushroom-head cap

use Front bezel flush

	Mushroom had cap	⌀ 24 x 48 mm Typ-Nr.	
Mushroom-head cap	Plastic black opaque	03-930.0	0.018
	Plastic green opaque	03-930.5	0.018
	Plastic red opaque	03-930.2	0.018
	Plastic yellow opaque	03-930.4	0.018



Keylock front bezel

	Keylock front bezel	Typ-Nr.	
Keylock front bezel Keylock switch Typ-Nr. 03-690, 03-691, 03-692	Plastic grey	03-980.1	0.010
	Keylock switch Typ-Nr. 03-695	03-982.1	0.010



Standard lock YB1, other lock numbers on request

Holder halved

for use with film insert; order 2 Holders

	Holder	Typ-Nr.	
Holder halved for Lens halved : Typ-Nr. 03-943.7 for Lens one-part, two-coloured : Typ-Nr. 03-951.7/7 and 03-952.1/1	Plastic blue translucent	03-922.6	0.001
	Plastic colourless translucent	03-922.7	0.001
	Plastic green translucent	03-922.5	0.001
	Plastic orange translucent	03-922.3	0.001
	Plastic red translucent	03-922.2	0.001
	Plastic white translucent	03-922.9	0.001
	Plastic yellow translucent	03-922.4	0.001



Holder one-part

for use with film insert

	Holder	Typ-Nr.	
Holder one-part for Lens one-part, unicoloured : Typ-Nr. 03-941.7, 03-946.7 and 03-947.1	Plastic blue translucent	03-908.6	0.001
	Plastic colourless translucent	03-908.7	0.001
	Plastic green translucent	03-908.5	0.001
	Plastic orange translucent	03-908.3	0.001
	Plastic red translucent	03-908.2	0.001
	Plastic white translucent	03-908.9	0.001
	Plastic yellow translucent	03-908.4	0.001



Diffuser plate halved

for film insert; order 2 Diffuser plates

	Typ-Nr.	
Diffuser plate halved for Lens halved and Lens one-part, two-coloured Lettering only visible when illuminated	03-926	0.001





Diffuser plate one-part

for film insert

	Typ-Nr.	
Diffuser plate one-part for Lens one-part, unicoloured Lettering only visible when illuminated	03-909	0.001



Front bezel flush

	Front bezel	 24 x 48 mm Typ-Nr.	
Front bezel flush	Plastic black	03-965.0	0.001



Front bezel raised

	Front bezel	 24 x 48 mm Typ-Nr.	
Front bezel raised Lens only removable with Lens remover Typ-Nr. 98-969	Plastic black	03-967.0	0.001





Light barrier

	Typ-Nr.	
Light barrier	03-907	0.002



Protective cover

use with Front bezel flush Typ-Nr. 03-965.0

	 24 x 48 mm Typ-Nr.	Technical drawing	
Protective cover hinged, transparent, with means for sealing	03-925	3	0.001



Technical drawing from page 28

Sprayproof cover

use Front bezel flush

	Front protection	24 x 48 mm Typ-Nr.	Mounting dimensions	Technical drawing	kg
Sprayproof cover three-part, PVC (-20 °C ... +60 °C)	IP 65	03-924	2	4	0.005



Mounting dimensions from page 28, Technical drawing from page 28

Blind plug

	Blind plug	24 x 48 mm Typ-Nr.	Mounting dimensions	kg
Blind plug	Plastic black	03-949.0	1	0.005
	Plastic grey	03-949.8	1	0.005



Mounting dimensions from page 28

Spare key

	Typ-Nr.	kg
Spare key Standard lock YB1	02-989.001	0.001



Other lock numbers on request

Backside

Terminal cover

	Typ-Nr.	kg
Terminal cover all connection methods	03-929	0.007



Illumination

Filament lamp

order 2 Filament lamps

Filament lamp	Socket	Operating voltage/-current	Typ-Nr.	
Filament lamp	T6.8	12 VAC/DC, 100 mA	10-1209.1329	0.001
		12 VAC/DC, 50 mA	10-1209.1279	0.001
		24 VAC/DC, 25 mA	10-1212.1199	0.001
		24 VAC/DC, 50 mA	10-1212.1279	0.001
		28 VAC/DC, 40 mA	10-1213.1249	0.001
		30 VAC/DC, 40 mA	10-1214.1249	0.001
		36 VAC/DC, 35 mA	10-1216.1229	0.001
		48 VAC/DC, 25 mA	10-1219.1199	0.001
		6 VAC/DC, 200 mA	10-1206.1369	0.001



Single-LED

order 2 LED's

Single-LED	Socket	Light colour	Operating voltage/-current	Typ-Nr.	
Single-LED	T6.8	blue	12 VAC/DC, 9/17 mA	10-2K09.1076	0.002
			24 VAC/DC, 9/17 mA	10-2K12.1076	0.002
			28 VAC/DC, 9/17 mA	10-2K13.1076	0.002
			48 VAC/DC, 4/8 mA	10-2K19.1056	0.002
			6 VDC, 17 mA	10-2K06.3156	0.002
		green	12 VAC/DC, 9/17 mA	10-2K09.1075	0.002
			24 VAC/DC, 9/17 mA	10-2K12.1075	0.002
			28 VAC/DC, 9/17 mA	10-2K13.1075	0.002
			48 VAC/DC, 4/8 mA	10-2K19.1055	0.002
			6 VDC, 17 mA	10-2K06.3155	0.002
		red	12 VAC/DC, 9/17 mA	10-2K09.1072	0.002
			24 VAC/DC, 9/17 mA	10-2K12.1072	0.002
			28 VAC/DC, 9/17 mA	10-2K13.1072	0.002
			48 VAC/DC, 4/8 mA	10-2K19.1052	0.002
			6 VDC, 17 mA	10-2K06.3152	0.002
		white diffuse	12 VAC/DC, 9/17 mA	10-2K09.1079	0.002
			24 VAC/DC, 9/17 mA	10-2K12.1079	0.002
			28 VAC/DC, 9/17 mA	10-2K13.1079	0.002
			48 VAC/DC, 4/8 mA	10-2K19.1059	0.002
			6 VDC, 17 mA	10-2K06.3159	0.002
		yellow	12 VAC/DC, 9/17 mA	10-2K09.1074	0.002
			24 VAC/DC, 9/17 mA	10-2K12.1074	0.002
			28 VAC/DC, 9/17 mA	10-2K13.1074	0.002
			48 VAC/DC, 4/8 mA	10-2K19.1054	0.002
			6 VDC, 17 mA	10-2K06.3154	0.002



Note:

AC operation through halve-wave rectifier possible, slight flickering can occur.

Series resistor

for lamp voltage reduction

	Operating voltage	Typ-Nr.	
Series resistor 10 kΩ, for filament lamp 48 VAC, 25 mA	230/240 V	02-904.7	0.003
2.7 kΩ, for filament lamp 48 VAC, 25 mA	110 V	02-904.0	0.003
3.3 kΩ, for filament lamp 48 VAC, 25 mA	125 V	02-904.1	0.003
4.7 kΩ, for filament lamp 48 VAC, 25 mA	145 V	02-904.3	0.003



Please keep to the country specific security rules.

Terminal plate empty

for fitting with series resistors

	Typ-Nr.	
Terminal plate empty 10 spaces 125 x 60 x 15 mm	02-912.2	0.045
15 spaces 187.5 x 60 x 15 mm	02-912.3	0.090
20 spaces 250 x 60 x 15 mm	02-912.4	0.095
5 spaces 62.5 x 60 x 15 mm	02-912.1	0.025



Assembling

Lens remover

	Typ-Nr.	
Lens remover for flush front bezel	02-905	0.011
for raised front bezel	98-968	0.004



Lamp remover

	Typ-Nr.	
Lamp remover Filament lamp	61-9740.0	0.003
LED	03-996	0.027



CAUTION

A switching process might be released when replacing the Lamp/LED !

Actuator with snap-action switching element

Switching system

1 or 2 self-cleaning, snap-action switching elements.
1 or 2 double-throw contacts.

Material

Material of contact

Standard version:
Silver (U >20 V)
Special versions: (on request)
Gold/Silver 700 Au/300 Ag (U <50 V)
Silver/Palladium 700 Ag/300 Pd (U >20 V) for atmospheres containing sulphur

Switch housing

Thermosetting material, heat-resistant

Indicator housing

Polyamide

Mechanical characteristics

Terminals

Screw terminal (with self-lifting clip):
max. wire cross-section, 2 x 2.5 mm²
max. wire cross-section of stranded cable, 2 x 1.5 mm²

Plug-in terminal 2.8 x 0.8 mm:
max. wire cross-section of stranded cable, 1 mm² can also be used as soldering terminal
max. wire cross-section, 2 x 1 mm²
max. wire cross-section of stranded cable: 2 x 0.75 mm²

Plug-in terminal 4.8 x 0.8 mm:
max. wire cross-section of stranded cable, 2.5 mm² can also be used as soldering terminal
max. wire cross-section: 2 x 1 mm²
max. wire cross-section of stranded cable, 2 x 0.75 mm²

Actuating force

6 N ... 12 N

Actuating travel

5 mm

Mechanical lifetime

Momentary action 2 million operations
Maintained action 1 million operations

Storage temperature

-30 °C ... +85 °C

Electrical characteristics

Standards

The switches comply with the "Standards for low-voltage switching devices" EN IEC 61058-1

Rated insulation voltage

400 VAC/440 VDC, as per IEC 61058-1

Conventional free air thermal current

10 A
The maximum current in continuous operation and at ambient temperature not exceeding the quoted maximum values.

Switch rating

400 VAC, 10 A, cosφ 0.95, as per IEC 61058-1
250 VAC, 10 A, as per UL

Electric strength

2500 VAC, 50 Hz, 1 min. between all terminals and earth, as per IEC 61058-1

Environmental conditions

Storage temperature

-30 °C ... +85 °C

Service temperature

-25 °C ... +55 °C
For indicators and illuminated pushbuttons mounted as a block, make sure the heat can escape freely.

Protection degree

Front side IP 40, IP 65 with spray cover, as per IEC 60529

Vibration resistance

10 g at 10-2000 Hz, amplitude 1.0 mm, as per IEC 60068-2-6

Approvals

Approbations

CB (IEC 61058-1/92)
CSA
ENEC (EN 61058-1/92)
Germanischer Lloyd
UL

Declaration of conformity

CE

Buzzer

Buzzer system

System

Contactless electronic buzzer with IC oscillator

Material

Alarm buzzer case

Duroplastic

Front cap

Polycarbonate (PC)

Front bezel

Polymethylacrylate

Mechanical characteristics

Terminals

Screw terminal

Operating temperature

-25 °C ... +55 °C

Storage temperature

-40 °C ... +85 °C

Front protection

IP 40

Electrical characteristics

Frequency (tone)

Approx. 2.8 kHz

Sound pressure

85 dB (A) \pm 8 dB at a distance of 0.1 m

Volume variable with a 1 M Ω potentiometer or corresponding fixed resistor

Operation Voltage/Current

typical

10 ... 55 VAC 10 ... 75 VDC

25 mA 15 mA

Approvals

Approbations

CB (IEC 61058-1/92)

ENEC (EN 61058-1/92)

Declaration of conformity

CE

Buzzer

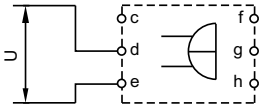

1. Supply voltage I
 Continous tone
 U = 10 - 35 VAC
 U = 10 - 50 VDC

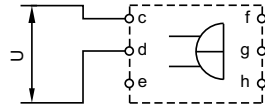

2. Supply voltage II
 Continous tone
 U = 35 - 55 VAC
 U = 35 - 75 VDC

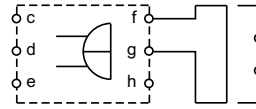

3. Intermittent tone
 Interval approx. 3 Hz

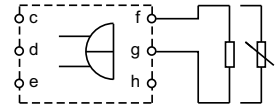

4. Volume control

Suppressor circuits

When switching inductive loads such as relays, DC motors, and DC solenoids, it is always important to absorb surges (e.g. with a diode) to protect the contacts. When these inductive loads are switched off, a counter emf can severely damage switch contacts and greatly shorten lifetime.

Fig. 1 shows an inductive load with a free-wheeling diode connected in parallel. This free-wheeling diode provides a path for the inductor current to flow when the current is interrupted by the switch. Without this free-wheeling diode, the voltage across the coil will be limited only by dielectric breakdown voltages of the circuit or parasitic elements of the coil. This voltage can be kilovolts in amplitude even when nominal circuit voltages are low (e.g. 12 VDC) see Fig. 2.

The free-wheeling diode should be chosen so that the reverse breakdown voltage is greater than the voltage driving the inductive load. The DC blocking voltage (VR) of the free-wheeling diode can be found in the datasheet of a diode. The forward current should be equal or greater than the maximum current flowing through the load.

To get an efficient protection, the free-wheeling diode must be connected as close as possible to the inductive load!

Switching with inductive load
Fig. 1

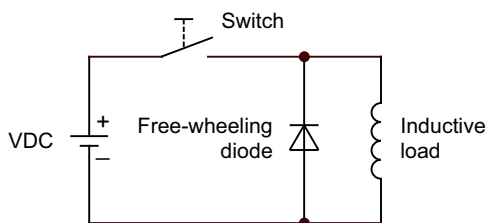

Counter emf
over load without free-wheeling diode
Fig. 2

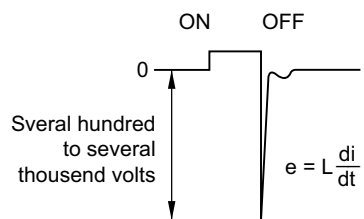

For Info: sales@switchesunlimited.com □ www.switchesunlimited.com □ Phone: 800-221-0487 □ Fax: 718-672-6370

General notes

1. Engraving

In addition to the most commonly used world languages, in DIN 1451-3 close spacing, other typefaces are available as Scandinavian, Slavic, Greek, Russian and Polish.

Red, blue and black lenses are filled with white colour. Other colour lenses are filled in black. Standard height of letters is 3 mm. If the height is not specified, we will supply 3 mm engraved letters.

2. Hot stamping

For larger series it is worth considering markings by means of hot stamping. We will be pleased to advise you. For letters and figures, typefaces with 2.5 mm, 3 mm and 4 mm are available.

3. Film inserts

Instead of using engraving the lenses can be fitted with transparent film inserts, as an alternative. For this purpose, though, it is advisable to use lenses without ripped pattern. In the case of use of a smoke-black lens the fitted film becomes readable only if the lamp is on.

The film (F) is inserted in the cap. To ensure even illumination a diffuser (D) is recommended, which is inserted beneath the film. If, on the other hand, the diffuser is inserted above the film, the lettering only becomes legible when the lamp is alight. To hold the film and diffuser in position, the use of a holder (N) is advised.

The film thickness is 0.2 mm.

All dimensions in mm

Lens size	Film insert max. size	Height of letters h	Number of lines	Number of (target value) capital letters per line	Number of (target value) small letters per line	Image
18 x 19	14.3 x 15.6	3	4	7 - 8	9 - 10	B3
		4	2	5	6	B4
		5	2	4	4	B3
		6	1	3	4	B4
		8	1	2	2	B3
		8	1	2	2	B4
18 x 38	14.3 x 34.3	3	4	16	18	B1
			8	6	8	B2
		4	2	11	13	B1
			4	4	5	B2
		5	2	8	10	B1
			4	3	4	B2
		6	1	7	9	B1
			3	3	3	B2
		8	1	5	6	B1
			2	2	2	B2

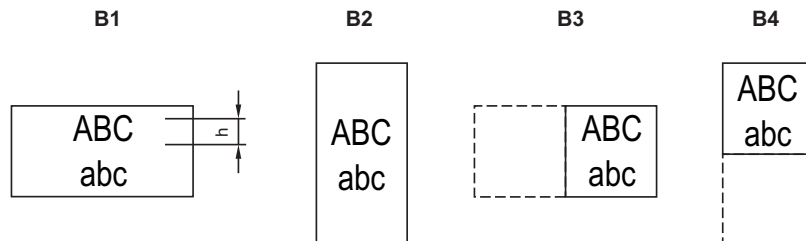
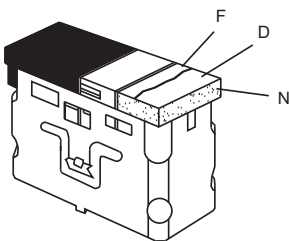

Mounting dimensions

1 Indicator actuator page 5 | Buzzer actuator page 5 | Pushbutton actuator one-part page 6 | Pushbutton actuator two-part page 7 | Pushbutton actuator locked mechanically page 8 | Illuminated pushbutton actuator one-part page 9 | Illuminated pushbutton actuator two-part page 10 | Illuminated pushbutton actuator locked mechanically page 11 | Mushroom-pushbutton actuator page 12 | Keylock switch actuator 2 positions page 13 | Mushroom-head keylock switch actuator 2 positions page 14 | Blind plug page 20

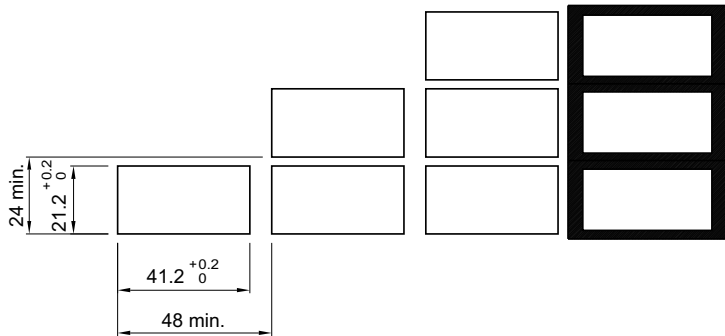

2 Sprayproof cover page 20

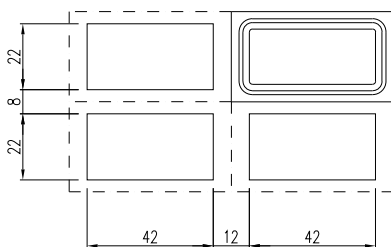

Technical drawing

1 Indicator actuator page 5

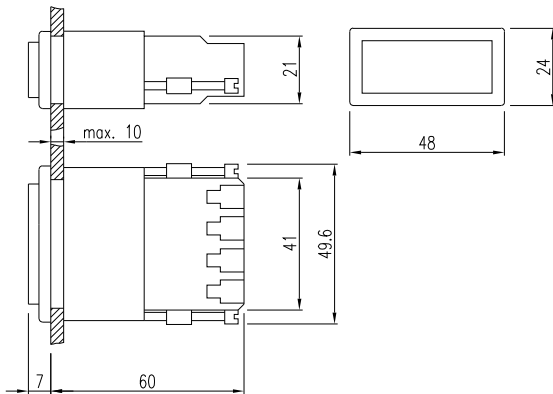

2 Buzzer actuator page 5

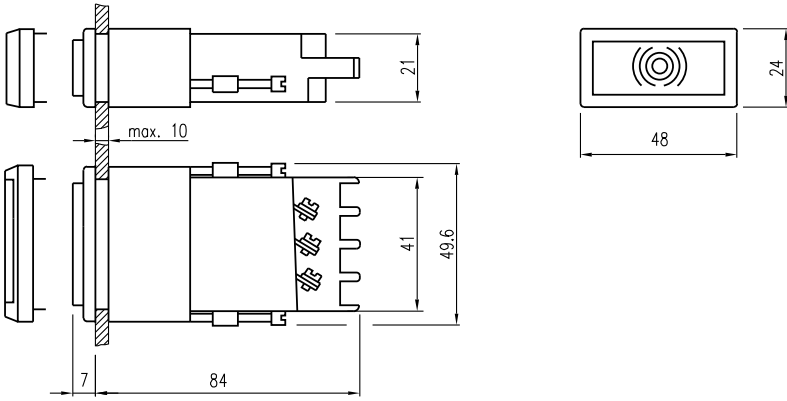

3 Protective cover page 19

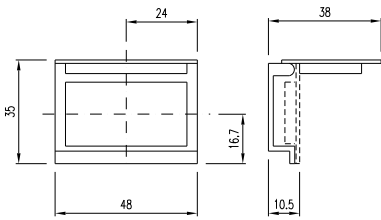

4 Sprayproof cover page 20

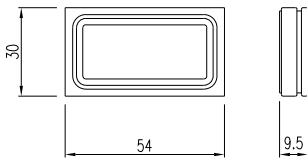

5 Pushbutton actuator one-part page 6 | Pushbutton actuator two-part page 7 | Illuminated pushbutton actuator one-part page 9 | Illuminated pushbutton actuator two-part page 10

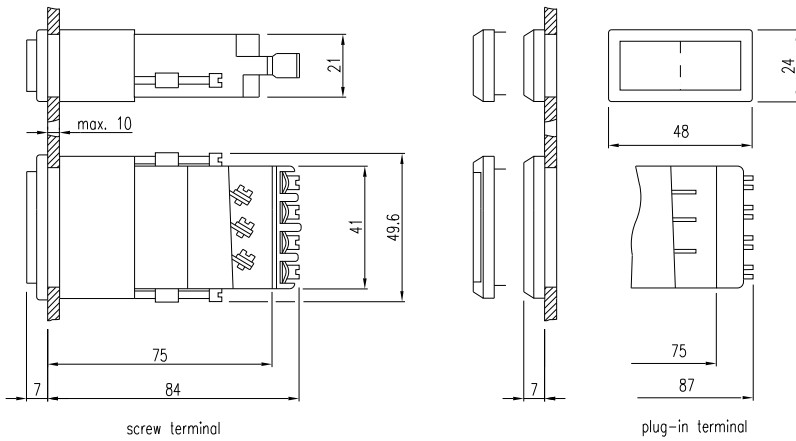

6 Keylock switch actuator 2 positions page 13

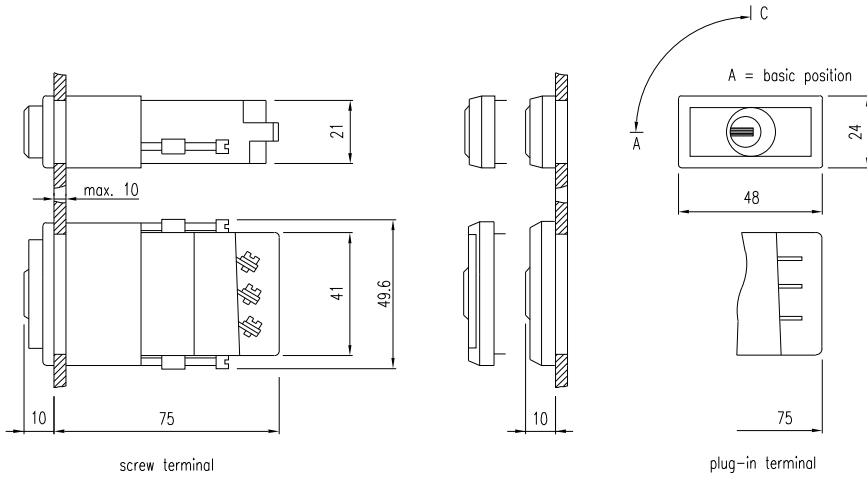

7 Mushroom-head keylock switch actuator 2 positions page 14

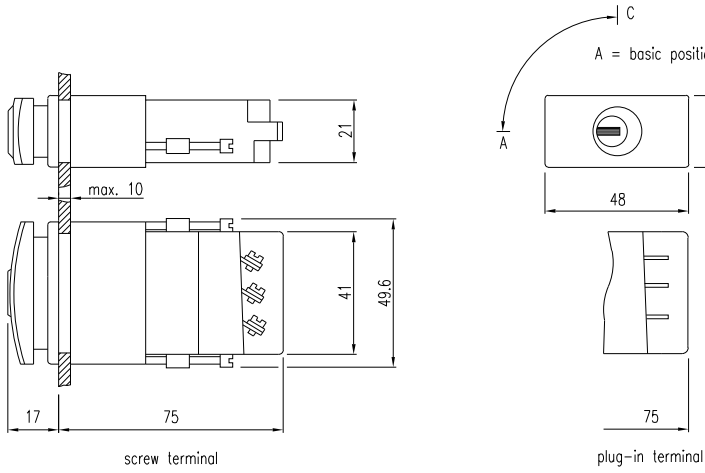

8 Mushroom-pushbutton actuator page 12

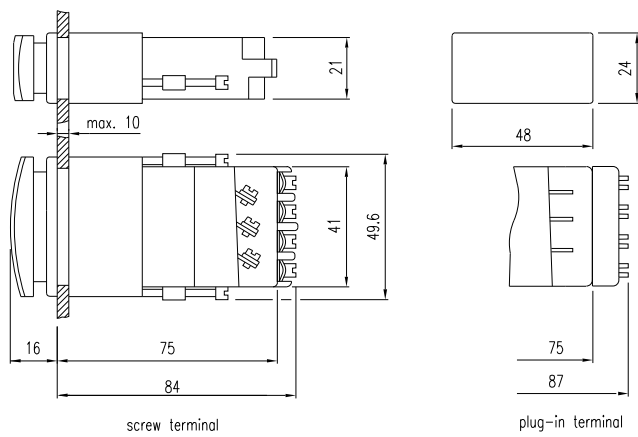

9 Pushbutton actuator locked mechanically page 8 | Illuminated pushbutton actuator locked mechanically page 11

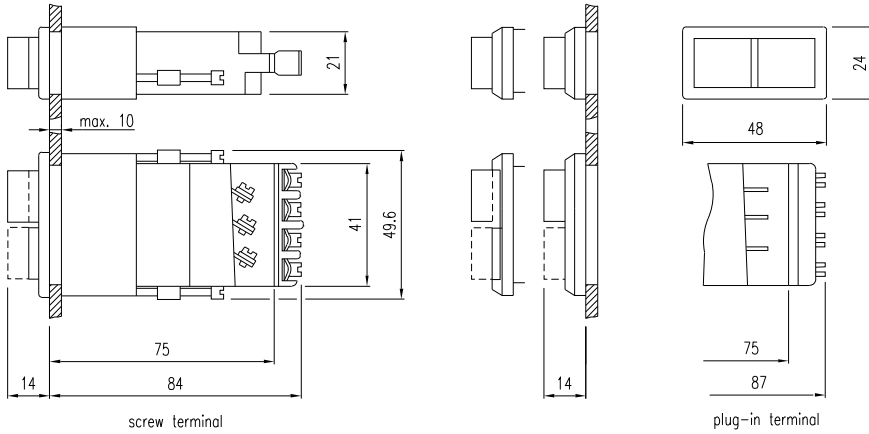

Circuit drawing

1 Buzzer actuator page 5

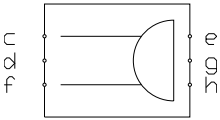

2 Indicator actuator page 5

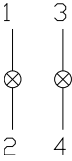

3 Pushbutton actuator one-part page 6

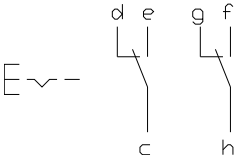

4 Illuminated pushbutton actuator one-part page 9 | Mushroom-pushbutton actuator page 12

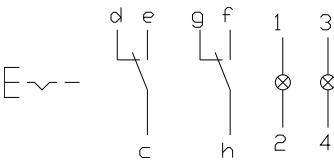

5 Illuminated pushbutton actuator one-part page 9 | Illuminated pushbutton actuator two-part page 10 | Mushroom-pushbutton actuator page 12

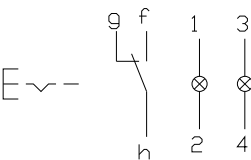

6 Pushbutton actuator one-part page 6

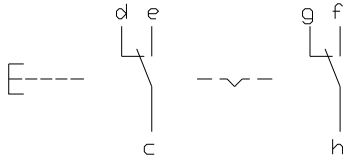

7 Pushbutton actuator one-part page 6

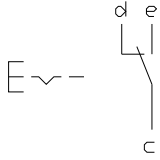

8 Pushbutton actuator one-part page 6

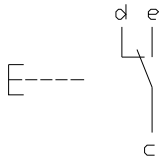

9 Pushbutton actuator one-part page 6

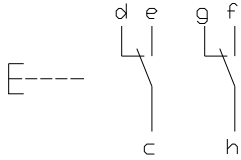

10 Pushbutton actuator two-part page 7 | **Pushbutton actuator locked mechanically** page 8

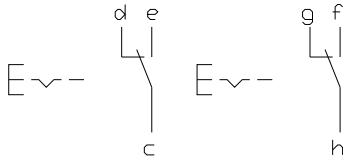

11 Pushbutton actuator two-part page 7

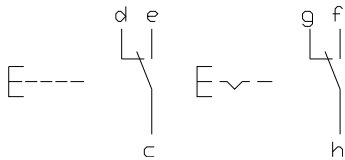

12 Pushbutton actuator two-part page 7

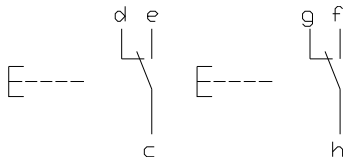

13 Illuminated pushbutton actuator one-part page 9 | **Illuminated pushbutton actuator two-part** page 10 | **Mushroom-pushbutton actuator** page 12

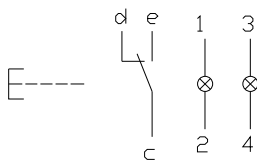

14 Illuminated pushbutton actuator one-part page 9 | **Mushroom-pushbutton actuator** page 12

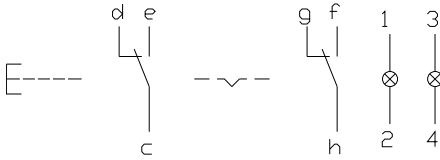

15 Illuminated pushbutton actuator one-part page 9 | **Mushroom-pushbutton actuator** page 12

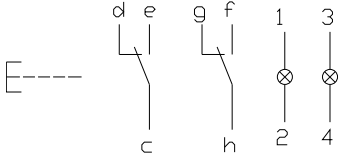

16 Illuminated pushbutton actuator two-part page 10 | **Illuminated pushbutton actuator locked mechanically** page 11

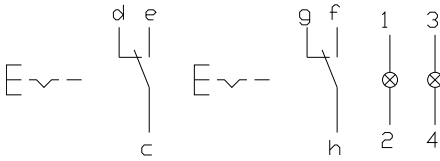

17 Illuminated pushbutton actuator two-part page 10 | **Illuminated pushbutton actuator locked mechanically** page 11

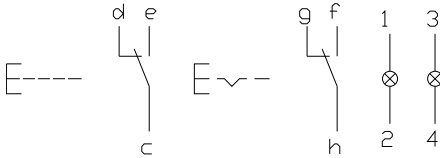

18 Illuminated pushbutton actuator two-part page 10 | **Illuminated pushbutton actuator locked mechanically** page 11

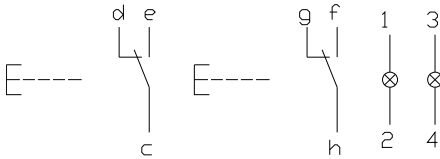

19 Keylock switch actuator 2 positions page 13 | **Mushroom-head keylock switch actuator 2 positions** page 14

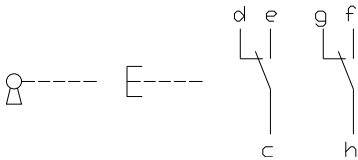

Index from Typ-Nr.

Typ-Nr.	Page	Typ-Nr.	Page	Typ-Nr.	Page
02-904.0	22	03-620.013	9	03-902.0/4	17
02-904.1	22	03-621.011	7	03-902.0/5	17
02-904.3	22	03-621.012	7	03-902.0/6	17
02-904.7	22	03-621.013	7	03-902.0/7	17
02-905	22	03-622.011	7	03-902.0/8	17
02-912.1	22	03-622.012	7	03-902.0/9	17
02-912.2	22	03-622.013	7	03-902.1/1	17
02-912.3	22	03-623.011	7	03-902.2/2	17
02-912.4	22	03-623.012	7	03-902.2/3	17
02-989.001	20	03-623.013	7	03-902.2/4	17
03-021.001	5	03-624.011	10	03-902.2/5	17
03-021.002	5	03-624.012	10	03-902.2/6	17
03-021.003	5	03-624.013	10	03-902.2/7	17
03-198.011	13	03-625.011	10	03-902.2/8	17
03-198.012	13	03-625.012	10	03-902.2/9	17
03-198.013	13	03-625.013	10	03-902.3/3	17
03-199.011	14	03-626.011	10	03-902.3/4	17
03-199.012	14	03-626.012	10	03-902.3/5	17
03-199.013	14	03-626.013	10	03-902.3/6	17
03-611.011	12	03-627.011	10	03-902.3/7	17
03-611.011	6	03-627.012	10	03-902.3/8	17
03-611.012	12	03-627.013	10	03-902.3/9	17
03-611.012	6	03-628.011	10	03-902.4/4	17
03-611.013	12	03-628.012	10	03-902.4/5	17
03-611.013	6	03-628.013	10	03-902.4/6	17
03-612.011	12	03-629.011	8	03-902.4/7	17
03-612.011	6	03-629.012	8	03-902.4/8	17
03-612.012	12	03-629.013	8	03-902.4/9	17
03-612.012	6	03-630.011	11	03-902.5/5	17
03-612.013	12	03-630.012	11	03-902.5/6	17
03-612.013	6	03-630.013	11	03-902.5/7	17
03-613.011	12	03-631.011	11	03-902.5/8	17
03-613.011	6	03-631.012	11	03-902.5/9	17
03-613.012	12	03-631.013	11	03-902.6/6	17
03-613.012	6	03-632.011	11	03-902.6/7	17
03-613.013	12	03-632.012	11	03-902.6/8	17
03-613.013	6	03-632.013	11	03-902.6/9	17
03-614.011	12	03-690.011	13	03-902.7/7	17
03-614.011	6	03-690.012	13	03-902.7/8	17
03-614.012	12	03-690.013	13	03-902.7/9	17
03-614.012	6	03-691.011	13	03-902.8/8	17
03-614.013	12	03-691.012	13	03-902.8/9	17
03-614.013	6	03-691.013	13	03-902.9/9	17
03-615.011	12	03-692.011	13	03-907	19
03-615.011	6	03-692.012	13	03-908.2	18
03-615.012	12	03-692.013	13	03-908.3	18
03-615.012	6	03-695.011	13	03-908.4	18
03-615.013	12	03-695.012	13	03-908.5	18
03-615.013	6	03-695.013	13	03-908.6	18
03-616.011	9	03-810.001	5	03-908.7	18
03-616.012	9	03-901.0	16	03-908.9	18
03-616.013	9	03-901.1	16	03-909	19
03-617.011	9	03-901.2	16	03-921.0	15
03-617.012	9	03-901.3	16	03-921.1	15
03-617.013	9	03-901.4	16	03-921.2	15
03-618.011	9	03-901.5	16	03-921.3	15
03-618.012	9	03-901.6	16	03-921.4	15
03-618.013	9	03-901.7	16	03-921.5	15
03-619.011	9	03-901.8	16	03-921.6	15
03-619.012	9	03-901.9	16	03-921.7	15
03-619.013	9	03-902.0/0	17	03-921.8	15
03-620.011	9	03-902.0/2	17	03-921.9	15
03-620.012	9	03-902.0/3	17	03-922.2	18

Index from Typ-Nr.

Typ-Nr.	Page	Typ-Nr.	Page	Typ-Nr.	Page
03-922.3	18	10-2K13.1072	21		
03-922.4	18	10-2K13.1074	21		
03-922.5	18	10-2K13.1075	21		
03-922.6	18	10-2K13.1076	21		
03-922.7	18	10-2K13.1079	21		
03-922.9	18	10-2K19.1052	21		
03-923.0	15	10-2K19.1054	21		
03-923.2	15	10-2K19.1055	21		
03-923.3	15	10-2K19.1056	21		
03-923.4	15	10-2K19.1059	21		
03-923.5	15	61-9740.0	22		
03-923.6	15	98-968	22		
03-923.7	15				
03-923.8	15				
03-923.9	15				
03-924	20				
03-925	19				
03-926	18				
03-929	20				
03-930.0	18				
03-930.2	18				
03-930.4	18				
03-930.5	18				
03-941.7	16				
03-942.7/7	17				
03-943.7	15				
03-946.7	16				
03-947.1	16				
03-949.0	20				
03-949.8	20				
03-951.7/7	17				
03-952.1/1	17				
03-953.7	15				
03-954.1	15				
03-965.0	19				
03-967.0	19				
03-980.1	18				
03-982.1	18				
03-996	22				
10-1206.1369	21				
10-1209.1279	21				
10-1209.1329	21				
10-1212.1199	21				
10-1212.1279	21				
10-1213.1249	21				
10-1214.1249	21				
10-1216.1229	21				
10-1219.1199	21				
10-2K06.3152	21				
10-2K06.3154	21				
10-2K06.3155	21				
10-2K06.3156	21				
10-2K06.3159	21				
10-2K09.1072	21				
10-2K09.1074	21				
10-2K09.1075	21				
10-2K09.1076	21				
10-2K09.1079	21				
10-2K12.1072	21				
10-2K12.1074	21				
10-2K12.1075	21				
10-2K12.1076	21				
10-2K12.1079	21				